



SWISS+TOOLS[®]

S W I S S
FLEX
20/10

SWISS+TOOLS[®]

Swiss Tool Systems AG / Wydenstrasse 28 / CH - 8575 Bürglen
Phone +41 (0)71 634 85 20 / Fax +41 (0)71 634 85 29 / www.swisstools.org



SCLC
Seite/page 13



SVUB / SVUC
Seite/page 15



SDNC
Seite/page 18



**Abstechhalter radial/
Cut-off block radial**
Seite/page 24



PCLN
Seite/page 13



DVUN
Seite/page 15



PDNN
Seite/page 18



**Abstechhalter axial/
Cut-off block axial**
Seite/page 24



PWLN
Seite/page 13



**SVJB / SVJC /
DVJN**
Seite/page 15



SVVB / SVVC
Seite/page 18



**Werkzeughalter axial einfach/
Tool holder axial single**
Seite/page 26



SDHC
Seite/page 14



SVPB / SVPC
Seite/page 16



DVVN
Seite/page 18

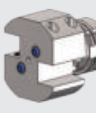

**Werkzeughalter axial doppelt/
Tool holder axial double**
Seite/page 26



PDHN
Seite/page 14



DVPN
Seite/page 16



SCLC
Seite/page 22



**Werkzeughalter axial dreifach/
Tool holder axial triple**
Seite/page 26



SDUC
Seite/page 14



SSBC
Seite/page 16



PCLN
Seite/page 22



**Werkzeughalter radial/
Tool holder radial**
Seite/page 26



PDUN
Seite/page 14



PSBN
Seite/page 16



SDQC
Seite/page 22



**Werkzeughalter diagonal/
Tool holder diagonal**
Seite/page 26



SDJC
Seite/page 14



SSSC
Seite/page 17



PDQN
Seite/page 22



**Verlängerung/
Extension**
Seite/page 27



PDJN
Seite/page 14



PSSN
Seite/page 17



**Modulare Bohrstangen/
Modular boring bars**
Seite/page 21



**Reduktion/
Reduction**
Seite/page 27



SCMC
Seite/page 17



**Bohrstangen-
halter/Boring
bar holder**
Seite/page 23



**Rohling/
Blank**
Seite/page 28



PCMN
Seite/page 17

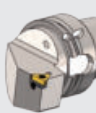

**Aussengewinde/
External thread**
Seite/page 25



**Spanneinheit/
Clamping unit**
Seite/page 28

NEW



**Multitask Werk-
zeuge/
Multitask tools**
Seite/page 19



**Innengewinde/
Internal thread**
Seite/page 25



**Ersatzteile/
Spare parts**
Seite/page 29



**Quick-Change
Werkzeughalter
Toolholders**
Seite/page 9+10



**Schwingungsgedämpfte Bohr-
stangenschäfte/Damped
boring bar shanks**
Seite/page 20

Bohrstangen mit Wechselschneidköpfen

- alle Wechselschneidköpfe sind mit Hochleistungskühlung ausgestattet.
- Werkzeugverschleiss tritt hauptsächlich am auswechselbaren Schneidkopf auf, der Adapter hält somit länger.
- In Kombination mit den SDT Bohrstangen ist das Konzept perfekt für Operationen mit langen Überhängen und bei Vibrationsneigung.

Boring bars with exchangeable cutting heads

- all exchangeable cutting heads are equipped with high performance coolant.
- Tool wear appears mainly at the changeable head, the life time of the tool adapter is therefore longer.
- In combination with SDT the tool concept is perfect for long cantilever extensions and while fighting with vibrations.

NEW
HP
inside

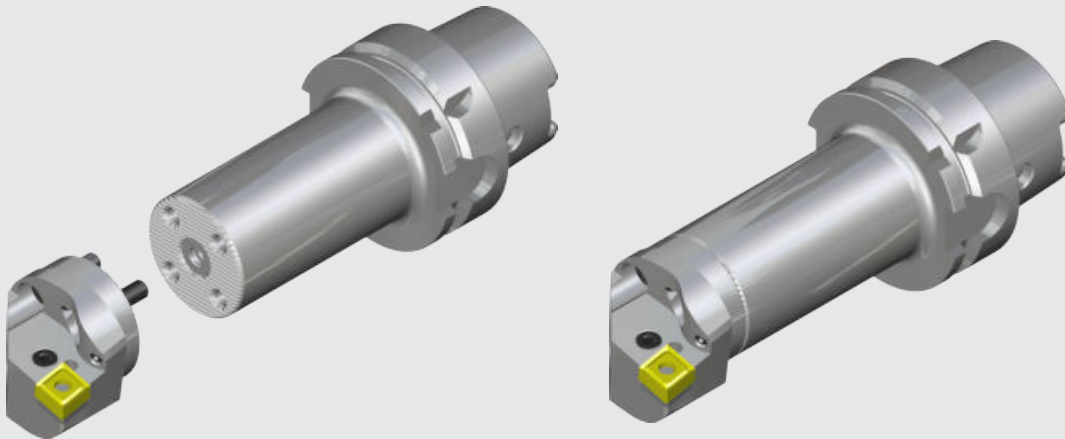

SWISS DAMPENING TECHNOLOGY

Schwingungsgedämpfte Bohrstangenschäfte

- Produktivitätsgewinn dank der unterdrückten Schwingungen können die Schnittdaten beträchtlich erhöht werden
- Verbesserte Oberflächengüte
- Verbesserte Prozesssicherheit
- Verbesserte Spanabfuhr
- Reduzierte Kosten pro Bauteil

Damped boring bar shanks

- Productivity improvement: thanks to reduced vibrations, the cutting conditions can be improved remarkable
- Better surface quality
- Improved process stability
- Better chip evacuation
- Reduced cost per part

NEW
SDT+
SWISS TOOLS

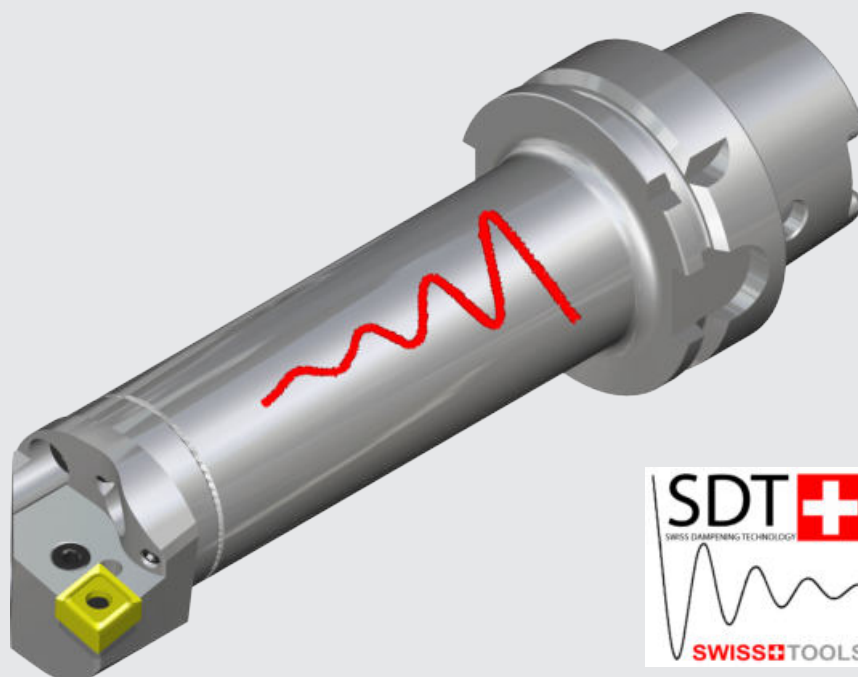

NEW

**QUICK-CHANGE Werkzeugsysteme
für Multi-Task und Drehmaschinen**

**QUICK-CHANGE tool system for
multi-tasking and turning lathes**

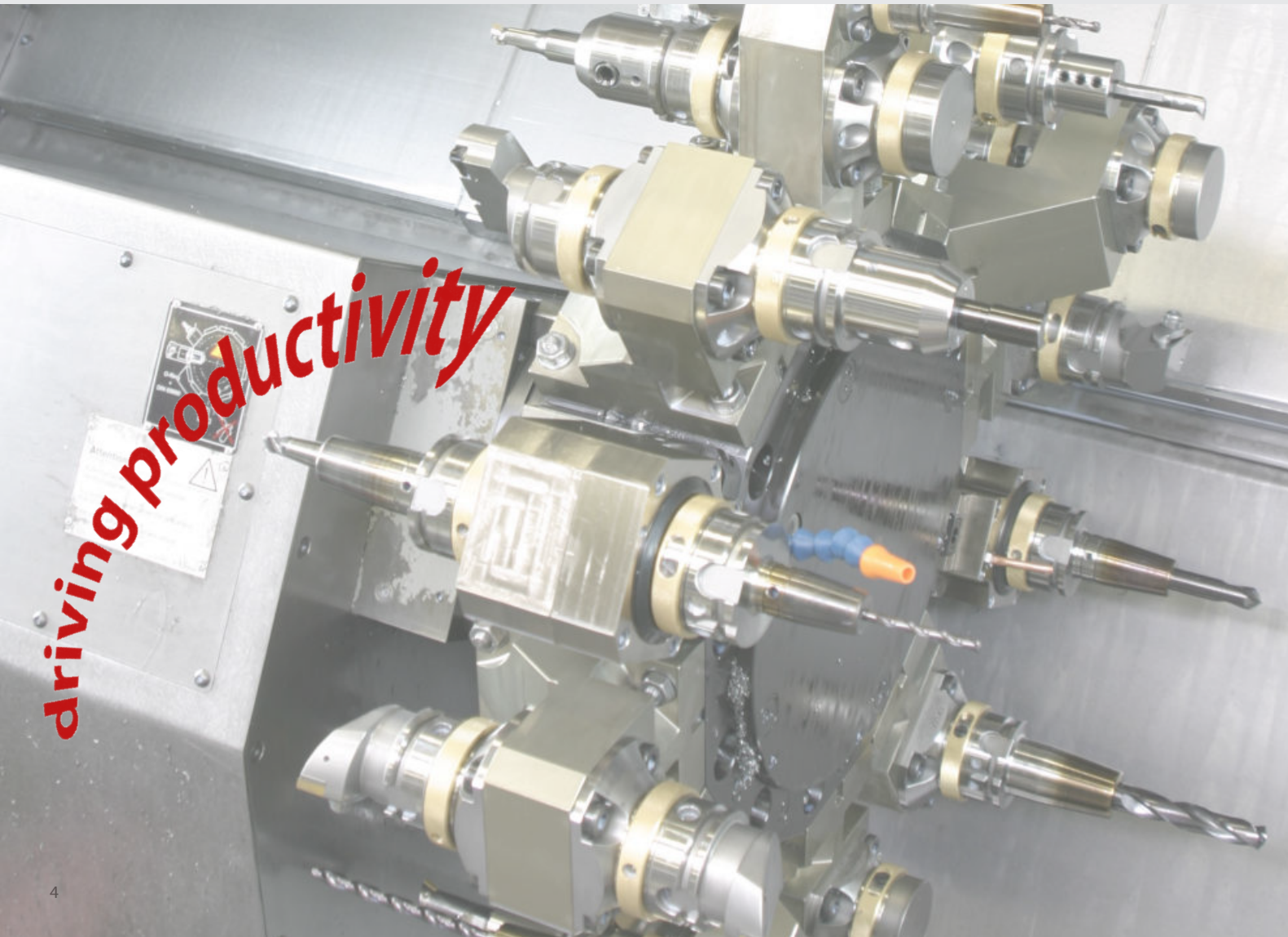

driving productivity

Systemlösungen /

System solution

- Produktivitätssteigerung durch Reduktion der Nebenzeiten.
- Werkzeugwechsel in kürzester Zeit
- Beste Wiederholgenauigkeit mit definierten, gleichbleibenden Werkzeugkonturen
- Für alle Maschinentypen geeignet.
- Flexibel für HSK, PSC und KM Werkzeuge
- Kosteneffizient System
- Increase productivity by reducing non-productive time
- Very quick tool changing time
- Perfect repeatability with fixed tool geometry
- Useable for all machine brands
- Flexible with HSK, PSC and KM tools
- Cost efficient

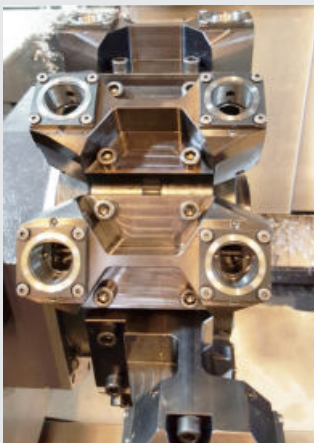

Online Konfigurator

- Angetriebene- und statische Werkzeuge für Drehmaschinen
- www.swisstools.org

Online configurator

- for static and rotating tools
- www.swisstools.org



Adaptionsmöglichkeiten Drehrevolverscheiben / Adaptation to turrets

Werkzeughalter mit Schnellwechselsystem

Das Werkzeughalterprogramm umfasst innovative und technisch ausgereifte Lösungen für alle gängigen CNC-Drehzentren. Wir bieten Ihnen Lösungen, die optimal auf das Maschinenfabrikat abgestimmt sind, ob mit BMT/ VDI oder anderen Anbindungen.

Die Schnittstelle des Schnellwechselsystems ist DIN/ISO normiert, und für die Größen HSK 40/63/100, PSC40/50/63 und KM 40/50/63 vorhanden.

Der Werkzeugwechsel ist einfach und schnell durchführbar. Die Nebenzeiten werden minimiert und damit die Produktivität gesteigert.

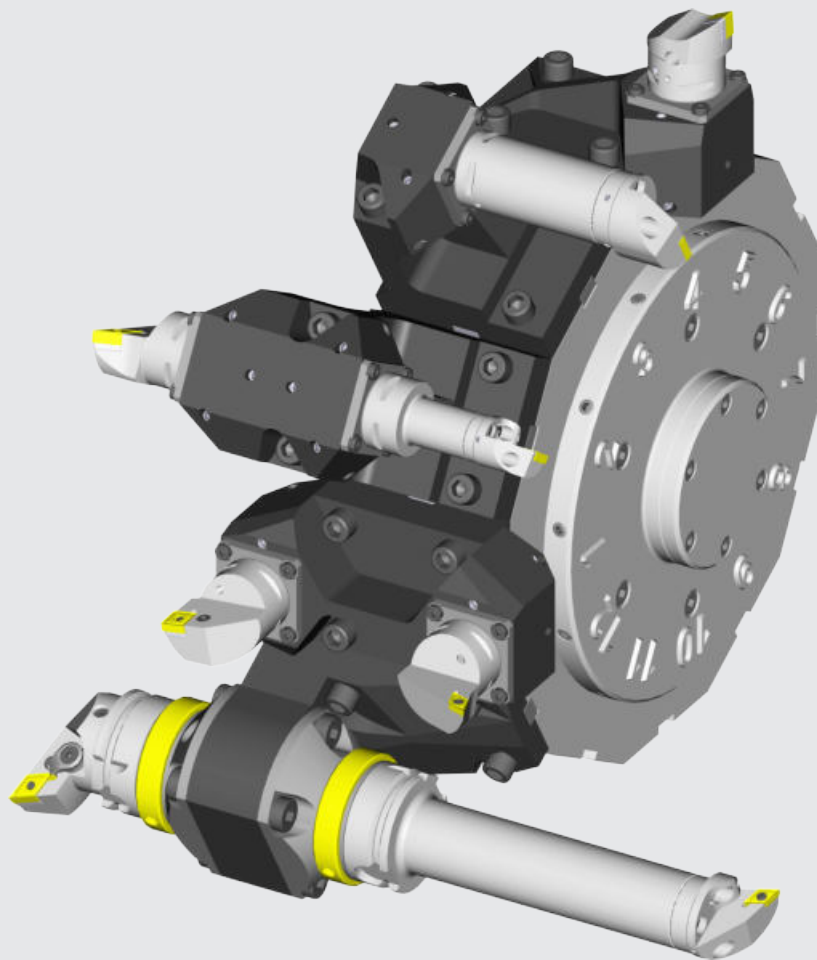

Tool holder with QUICK-CHANGE system

The whole range of the system contains solutions for the most CNC lathes centres. Complementary on the machine tool with BMT / VDI or other connections.

The tool connection is based on DIN/ISO standards with HSK 40/63/100, PSC40/50/63 and KM 40/50/63.

The tool change is very simple and quick. Non-productive times are minimized and the productivity will increase.

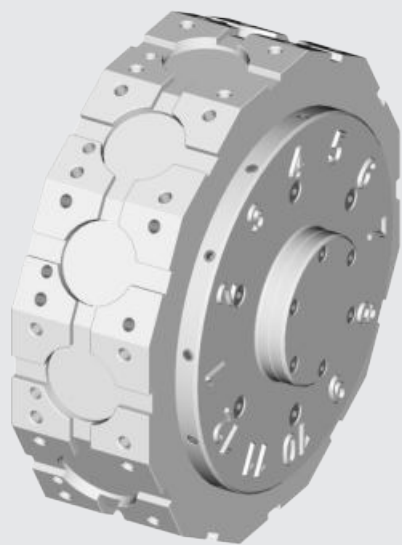

**Revolverscheibe / Turret
BMT/VDI/...**

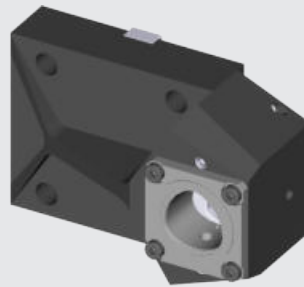

**Werkzeughalter
einfach gerade**

**Tool holder
single straight**

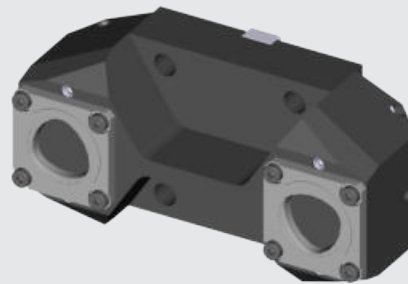

**Werkzeughalter
doppelt gerade**

**Tool holder
double straight**

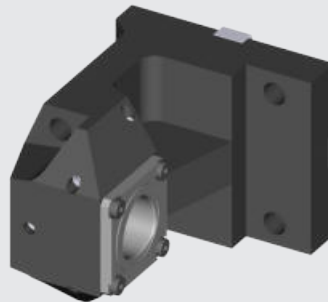

**Werkzeughalter
einfach abgewinkelt**

**Tool holder
single angular**

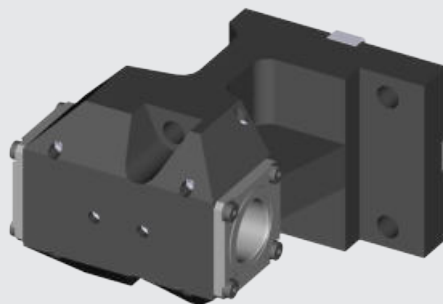

**Werkzeughalter
doppelt abgewinkelt**

**Tool holder
double angular**

HSK / PSC / KM Spanneinheiten /

HSK / PSC / KM clamping unit

Die Werkzeughalter werden entweder mit einer HSK oder einer PSC Spanneinheit ausgerüstet.

Die Werkzeughalter sind somit flexibel auf die Kundenbedürfnisse anpassbar.

Spanneinheiten sind in den Grössen HSK 40/63/100, PSC40/50/63 und KM 40/50/63 erhältlich

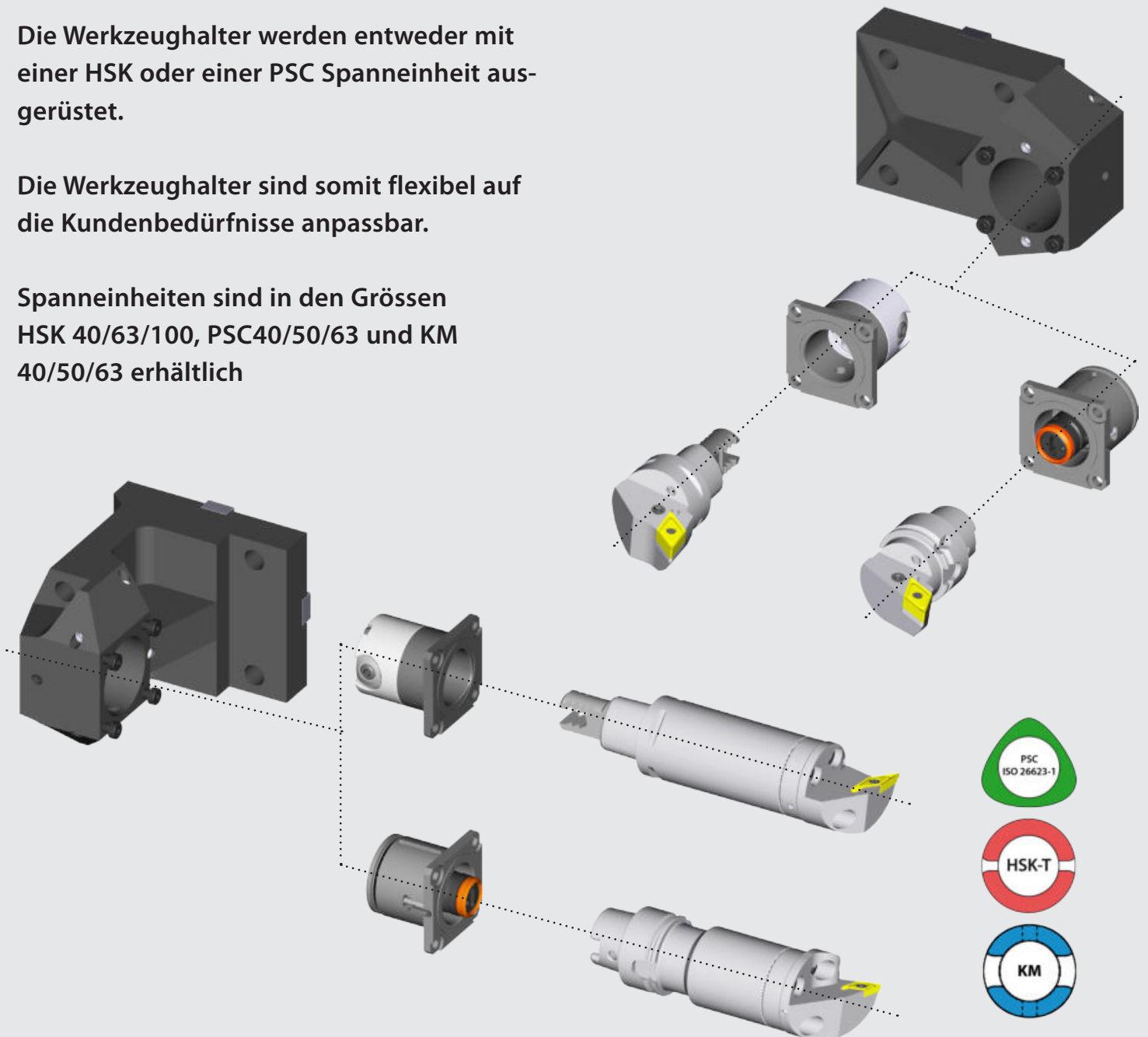

Tool holders are equipped with HSK or PSC clamping units.

Very flexible for customer needs.

Clamping units are available in HSK 40/63/100, PSC40/50/63 and KM 40/50/63.

**Quick-Change Werkzeughalter
und Spanneinheiten**

**Quick-Change Toolholders
and clamping units**

**Werkzeughalter mit VDI Schaft
abgewinkelt / DIN 69880**

**Toolholder with VDI shank
angular / DIN 69880**

- Mitnehmernuten am HSK nach ISO 12164-3
- Schaft mit Doppelverzahnung R/L Einsatz möglich
- für Innenkühlung

- drive key way of HSK shank according to ISO 12164-3
- shank with double serration profile R/L usage possible
- for inner coolant supply

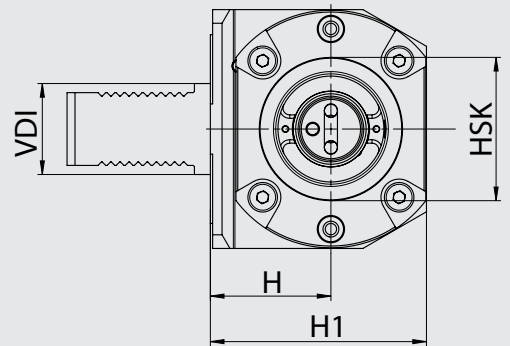
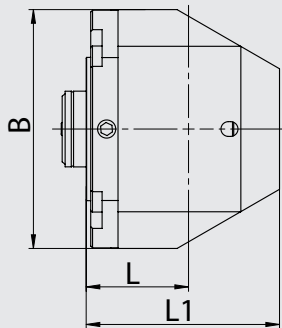
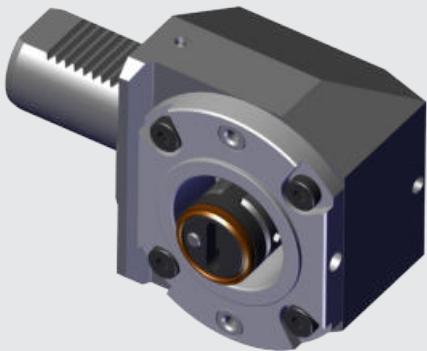

Bestell-Nr. / Order number	HSK T	H	H1	VDI	L	L1	B
REA.HA4.VD3.041-11	40	41	63	30	32	62	68
REA.HA4.VD4.051	40	51	75	40	34	90	75
REA.HA6.VD4.053	63	53	95	40	45	85	105
REA.HA6.VD5.055	63	55	97	50	45	85	105

**Werkzeughalter mit VDI Schaft
gerade / DIN 69880**

**Toolholder with VDI shank
straight / DIN 69880**

- Mitnehmernuten am HSK nach ISO 12164-3
- Schaft mit Doppelverzahnung R/L Einsatz möglich
- für Innenkühlung

- drive key way of HSK shank according to ISO 12164-3
- shank with double serration profile R/L usage possible
- for inner coolant supply

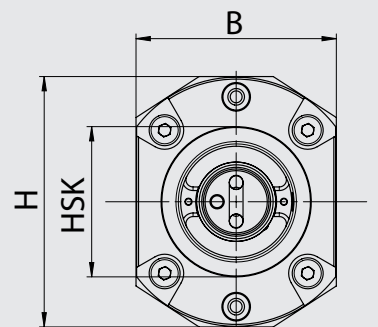
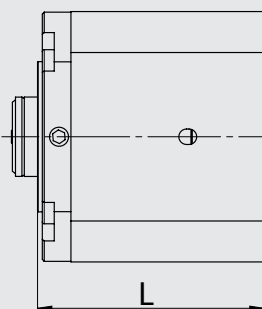
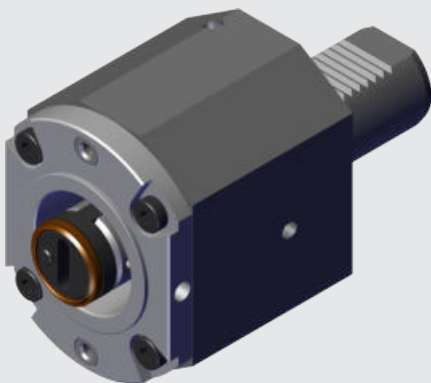

Bestell-Nr. / Order number	HSK T	L	H	VDI	B
RER.HA4.VD3.065-11	40	65	68	30	52
RER.HA4.VD3.074	40	74	60	30	52
RER.HA4.VD4.079	40	79	75	40	75
RER.HA6.VD4.095-11	63	95	105	40	84
RER.HA6.VD5.105-11	63	105	105	50	84
RER.HA6.VD6.105-11	63	105	105	60	84

Quadratischer Schaft

- Mitnehmernuten am HSK nach ISO 12164-3
- Anschluss für Innenkühlung

Rectangular shank

- drive key way of HSK shank according to ISO 12164-3
- Coupling for inner coolant supply

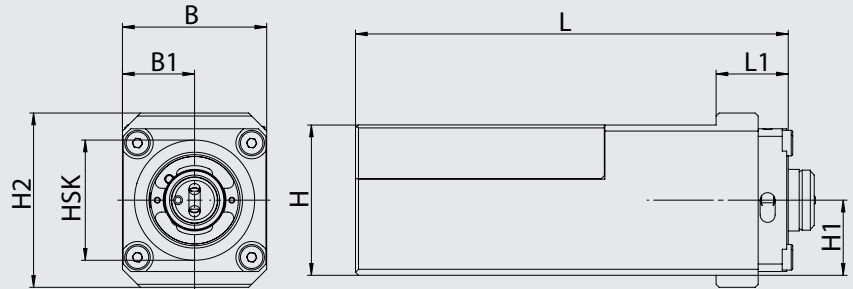
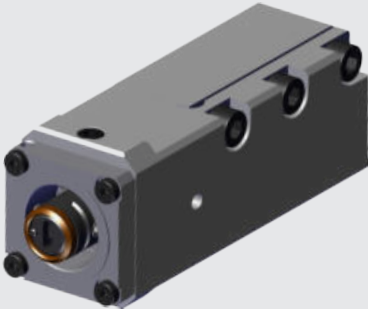

Bestell-Nr. / Order number	HSK T	B	B1	H	H1	H2	L	L1
RER.HA4.V20.144	40	48	24	40	20	58	144	54
RER.HA4.V25.144	40	48	24	50	25	58	144	61
RER.HA4.V32.139	40	48	24	64	32	64	139	56

Bezeichnung von HSK Klemmhalter für Aussenbearbeitung Identification of external HSK turning tool holder

HSK-T63 | D | C | L | N | R | 45 070 12
 1 | 2 | 3 | 4 | 5 | 6 | 7 | 8 | 9

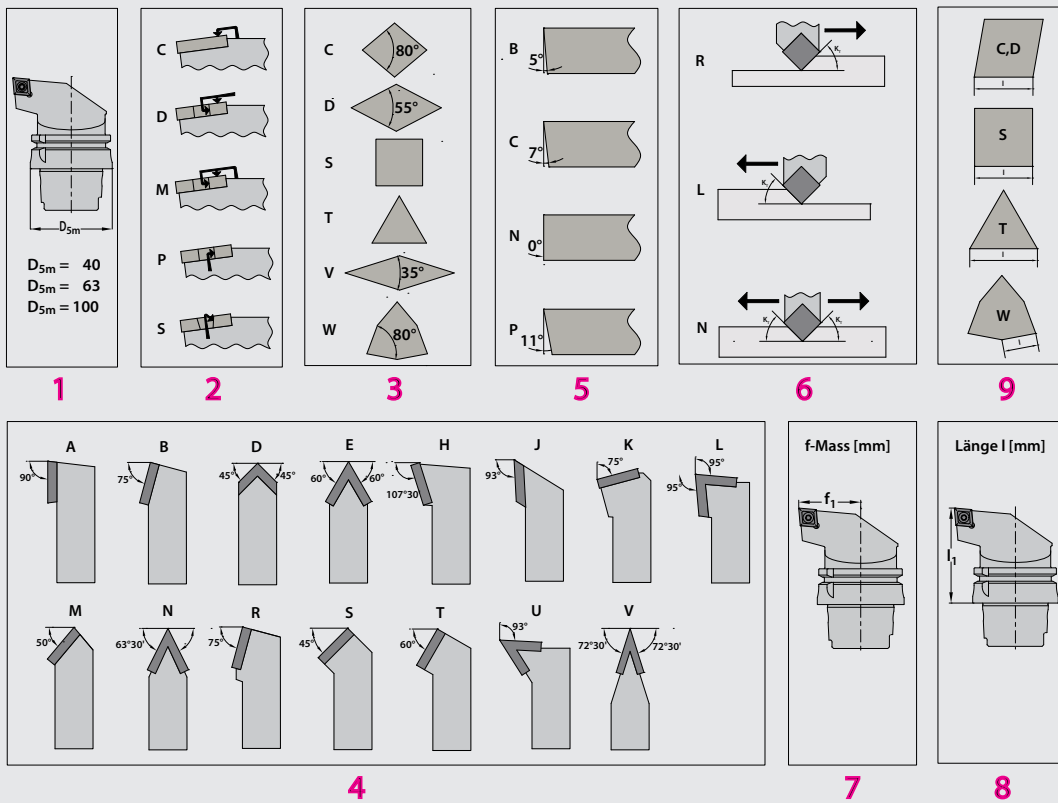

Bezeichnung von HSK Klemmhalter für Innenbearbeitung Identification of external HSK turning tool holder

HSK-T63 | S | C | L | C | R | - | 27180 | - | 09
 1 | 2 | 3 | 4 | 5 | 6 | 7 | 8

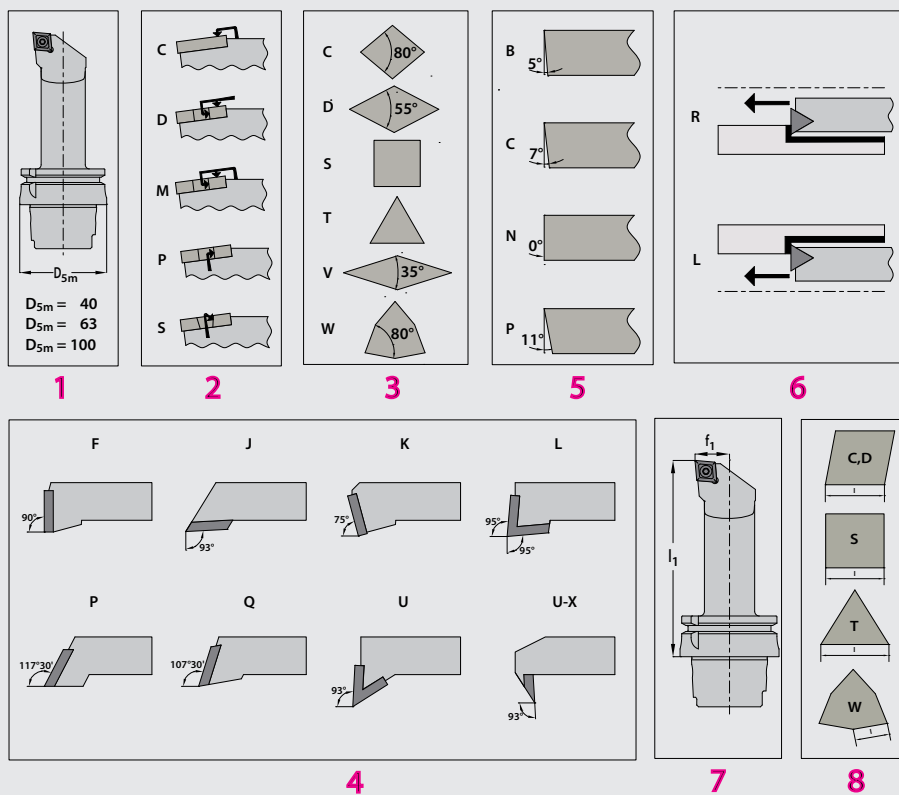

NEW
HP
ready

Hochleistungskühlung

- für effiziente Drehbearbeitung
- optimale Kühlung durch fest ausgerichtete **High Pressure** Kühldüsen
- verbesserte Spankontrolle
- höhere Bearbeitungssicherheit
- mehr Zerspanvolumen
- kürzere Bearbeitungszeiten

High performance coolant

- to turn efficiently
- optimal cooling by fix orientated **High Pressure** coolant nozzles
- improved chip control
- higher manufacturing security
- higher chip removal rate
- shorter machining time

Klemmhalter

- alle Klemmhalter die mit dem **HP ready** Symbol markiert sind, können auf Hochleistungskühlung aufgerüstet werden.

Turning tool

- all turning tools which are marked with the **HP ready** symbol, can be set up with the high performance coolant.

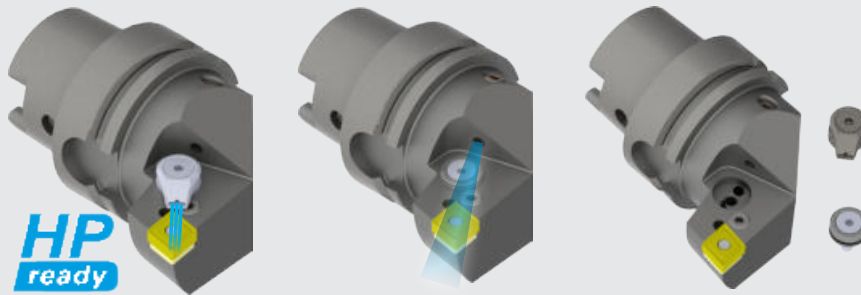

Bestell-Nr. /
Order number

CHP.PCX.000.022

HP
ready

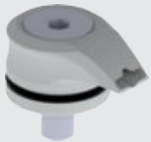

- Hochleistungskühlmittel Set beinhaltet:
 - HP Düse
 - O-Ring

- High performance coolant set included:
 - HP coolant nozzle
 - O-ring

Kühlung und Klemmsysteme

Cooling and clamping systems

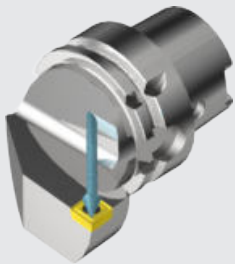

- Spannsystem: Die Wendeplatte wird mittels Schraubenklemmung Typ S gespannt.
- Kühlsystem: Klemmhalter für positive Wendeplatten besitzen eine ausgerichtete Kühlmitteldüse.

- Clamping system: The insert is tightened via screw clamping Type S.
- Cooling system: Turning tools for positive inserts feature an adjusted coolant nozzle.

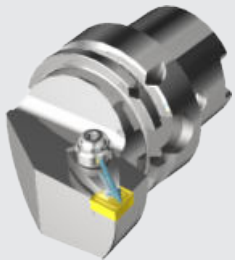

- Spannsystem: Die Wendeplatte wird mittels Doppelklemmung Typ D gespannt.
- Kühlsystem: Klemmhalter mit Doppelklemmung verfügen über eine ausrichtbare Hochdruckkühldüse.

- Clamping system: The insert is tightened via double-clamping Type D.
- Cooling system: Turning tools with double-clamping feature an adjustable high-pressure coolant nozzle.

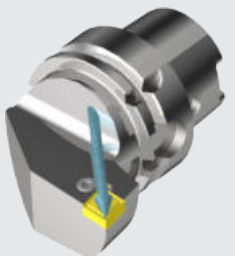

- Spannsystem: Die Wendeplatte wird mittels Kniehebelspannung Typ P gespannt.
- Kühlsystem: Klemmhalter mit Kniehebelspannung besitzen eine ausgerichtete Kühlmitteldüse.

- Clamping system: The insert is tightened via knuckle joint Type P.
- Cooling system: Turning tools with knuckle joint-clamping feature an adjusted coolant nozzle.

Klemmhalter

- für effiziente Drehbearbeitung
- optimale Kühlung durch ausgerichtete Kühldüse und Hochdruckkühldüse
- Mitnehmernuten am HSK nach ISO 12164-3
- Klemmhalter für Aussenbearbeitung können auch für die Innenbearbeitung verwendet werden unter Berücksichtigung des D1 min.

Turning tool

- to turn efficiently
- optimal cooling by adjusted cooling nozzle and high pressure cooling nozzle
- drive key way of HSK shank according to ISO 12164-3
- Turning tools for exterior machining may also be used for interior machining, in consideration of D1 min.

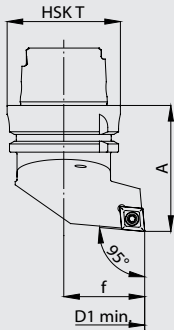

SCLC R/L 95°/80°



Bestell-Nr. / Order number	HSK T	f	D1 min.	A	Wendeplatte/ Insert	Ersatzteile/ Spareparts
HA4.KCB.(R/L)LA.055-HP	40	27	50	55	CC .. 09 T3 ..	S05
HA4.KCC.(R/L)LA.055-HP	40	27	50	55	CC .. 12 04 ..	S01
HA6.KCB.(R/L)LA.070-HP	63	45	80	70	CC .. 09 T3 ..	S05
HA6.KCC.(R/L)LA.070-HP	63	45	80	70	CC .. 12 04 ..	S01
HA0.KCC.(R/L)LA.100-HP	100	63	120	100	CC .. 12 04 ..	S01

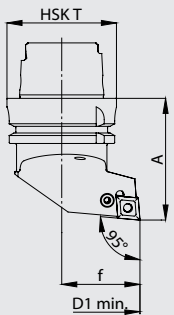

PCLN R/L 95°/80°



Bestell-Nr. / Order number	HSK T	f	D1 min.	A	Wendeplatte/ Insert	Ersatzteile/ Spareparts
HA4.PCD.(R/L)LA.055-HP	40	27	50	55	CN .. 12 04 ..	P01
HA6.PCD.(R/L)LA.070-HP	63	45	80	70	CN .. 12 04 ..	P01
HA6.PCE.(R/L)LA.070-HP	63	45	80	70	CN .. 16 06 ..	P02
HA0.PCD.(R/L)LA.100-HP	100	63	120	100	CN .. 12 04 ..	P01
HA0.PCE.(R/L)LA.100-HP	100	63	120	100	CN .. 16 06 ..	P02
HA0.PCF.(R/L)LA.100-HP	100	63	120	100	CN .. 19 06 ..	P09

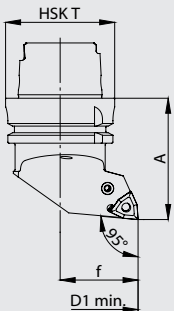

PWLN R/L 95°/80°



Bestell-Nr. / Order number	HSK T	f	D1 min.	A	Wendeplatte/ Insert	Ersatzteile/ Spareparts
HA4.PWD.(R/L)LA.055-HP	40	27	50	55	WN .. 06 04 ..	P0x
HA4.PWE.(R/L)LA.055-HP	40	27	50	55	WN .. 08 04 ..	P04
HA4.PWE.(R/L)LA.055-HP	40	27	50	55	WN .. 08 04 ..	P04
HA6.PWE.(R/L)LA.070-HP	63	45	80	70	WN .. 08 04 ..	P04
HA0.PWE.(R/L)LA.100-HP	100	63	120	100	WN .. 08 04 ..	P04



Bestell-Nr. / Order number

CHP.PCX.000.022



- Hochleistungskühlmittel Set beinhaltet:
 - HP Düse
 - O-Ring

- High performance coolant set included:
 - HP coolant nozzle
 - O-ring

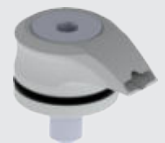



SDHC R/L 107.5°/55°



Bestell-Nr. / Order number	HSK T	f	D1 min.	A	Wendeplatte/ Insert	Ersatzteile/ Spareparts
HA4.KDB.(R/L)HA.055-HP	40	27	50	55	DC..11 T3..	S05
HA6.KDB.(R/L)HA.070-HP	63	45	80	70	DC..11 T3..	S05
HA0.KDB.(R/L)HA.100	100	63	120	100	DC..11 T3..	S05

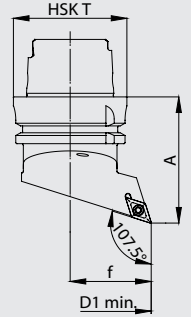

PDHN R/L 107.5°/55°



Bestell-Nr. / Order number	HSK T	f	D1 min.	A	Wendeplatte/ Insert	Ersatzteile/ Spareparts
HA4.PDF.(R/L)HA.055-HP	40	27	50	55	DN..15 06..*	P05
HA6.PDE.(R/L)HA.070-HP	63	45	80	70	DN..11 04..	P08
HA6.PDF.(R/L)HA.070-HP	63	45	80	70	DN..15 06..*	P05
HA0.PDF.(R/L)HA.100-HP	100	63	120	100	DN..15 06..*	P05

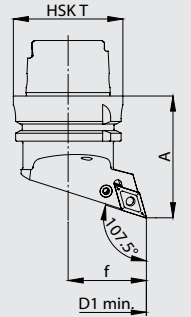

SDUC R/L 93°/55°

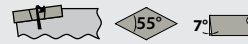

Bestell-Nr. / Order number	HSK T	f	D1 min.	A	Wendeplatte/ Insert	Ersatzteile/ Spareparts
HA4.KDB.(R/L)UA.055	40	27	50	55	DC..11 T3..	S05
HA6.KDB.(R/L)UA.070	63	45	80	70	DC..11 T3..	S05
HA0.KDB.(R/L)UA.100	100	63	120	100	DC..11 T3..	S05

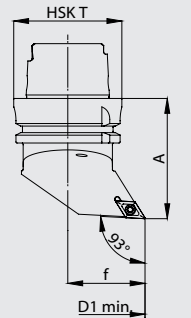

PDUN R/L 93°/55°



Bestell-Nr. / Order number	HSK T	f	D1 min.	A	Wendeplatte/ Insert	Ersatzteile/ Spareparts
HA4.PDF.(R/L)UA.055	40	27	50	55	DN..15 06..*	P05
HA6.PDE.(R/L)UA.070-HP	63	45	80	70	DN..11 04..	P08
HA6.PDF.(R/L)UA.070-HP	63	45	80	70	DN..15 06..*	P05
HA0.PDF.(R/L)UA.100-HP	100	63	120	100	DN..15 06..*	P05

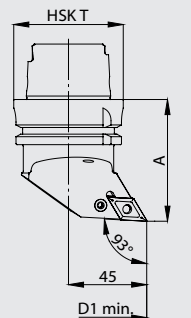

SDJC R/L 55°/93°



Bestell-Nr. / Order number	HSK T	f	D1 min.	A	Wendeplatte/ Insert	Ersatzteile/ Spareparts
HA4.KDB.(R/L)JA.055-HP	40	27	50	55	DC..11 T3..	S05
HA6.KDB.(R/L)JA.070-HP	63	45	80	70	DC..11 T3..	S05
HA0.KDB.(R/L)JA.100	100	63	120	100	DC..11 T3..	S05

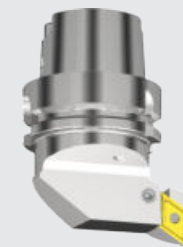
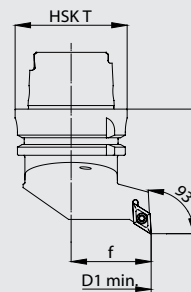

PDJN R/L 55°/93°



Bestell-Nr. / Order number	HSK T	f	D1 min.	A	Wendeplatte/ Insert	Ersatzteile/ Spareparts
HA4.PDF.(R/L)JA.055-HP	40	27	-	57	DN..15 06..*	P05
HA6.PDE.(R/L)JA.070-HP	63	45	-	70	DN..11 04..	P08
HA6.PDF.(R/L)JA.070-HP	63	45	-	70	DN..15 06..*	P05
HA0.PDF.(R/L)JA.100-HP	100	63	-	100	DN..15 06..*	P05

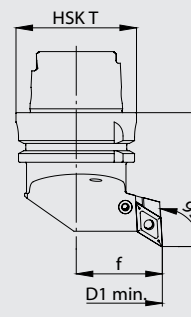

* DN..15 04.. möglich mit Unterlegplatte WDF.ER2.101.004

* DN..15 04.. possible with tip pad WDF.ER2.101.004

SVUB R/L 93°/35°

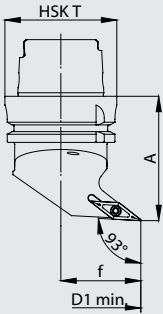

Bestell-Nr. / Order number	HSK T	f	D1 min.	A	Wendeplatte/ Insert	Ersatzteile/ Spareparts
HA4.KVF.(R/L)UA.055	40	27	50	55	VB .. 16 04 ..	S07
HA6.KVF.(R/L)UA.070	63	45	80	70	VB .. 16 04 ..	S07
HA0.KVF.(R/L)UA.100	100	63	120	100	VB .. 16 04 ..	S07



SVUC R/L 93°/35°

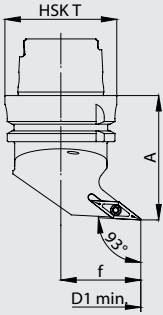

Bestell-Nr. / Order number	HSK T	f	D1 min.	A	Wendeplatte/ Insert	Ersatzteile/ Spareparts
HA4.KVB.(R/L)UA.055	40	27	50	55	VC .. 16 04 ..	S07
HA6.KVB.(R/L)UA.070-HP	63	45	80	70	VC .. 16 04 ..	S07
HA0.KVB.(R/L)UA.100	100	63	120	100	VC .. 16 04 ..	S07



DVUN R/L 93°/35°

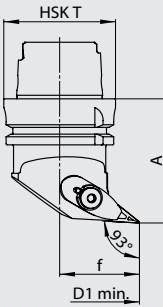
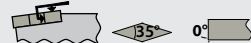

Bestell-Nr. / Order number	HSK T	f	D1 min.	A	Wendeplatte/ Insert	Ersatzteile/ Spareparts
HA4.KVD.(R/L)UA.055	40	27	-	55	VN .. 16 04 ..	D07
HA6.KVD.(R/L)UA.070	63	45	80	70	VN .. 16 04 ..	D07
HA0.KVD.(R/L)UA.100	100	63	120	100	VN .. 16 04 ..	D07



SVJB R/L 35°/93°

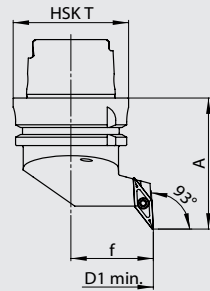
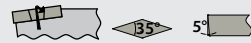

Bestell-Nr. / Order number	HSK T	f	D1 min.	A	Wendeplatte/ Insert	Ersatzteile/ Spareparts
HA4.KVE.(R/L)JA.055	40	27	50	55	VB .. 11 03 ..	S10
HA4.KVF.(R/L)JA.060	40	27	50	60	VB .. 16 04 ..	S07
HA6.KVF.(R/L)JA.070	63	45	80	71.5	VB .. 16 04 ..	S07
HA0.KVF.(R/L)JA.100	100	63	120	100	VB .. 16 04 ..	S07



SVJC R/L 35°/93°

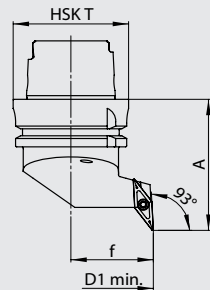

Bestell-Nr. / Order number	HSK T	f	D1 min.	A	Wendeplatte/ Insert	Ersatzteile/ Spareparts
HA4.KVA.(R/L)JA.055	40	27	50	55	VC .. 11 T3 ..	S10
HA4.KVB.(R/L)JA.060	40	27	50	60	VC .. 16 04 ..	S07
HA6.KVB.(R/L)JA.070	63	45	80	71.5	VC .. 16 04 ..	S07
HA0.KVB.(R/L)JA.100	100	63	120	100	VC .. 16 04 ..	S07



DVJN R/L 93°/35°

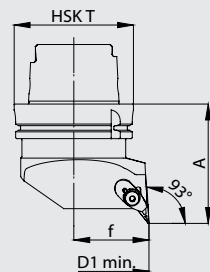
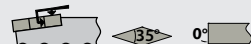

Bestell-Nr. / Order number	HSK T	f	D1 min.	A	Wendeplatte/ Insert	Ersatzteile/ Spareparts
HA6.KVD.(R/L)JA.070	63	45	-	70	VN .. 16 04 ..	D07
HA0.KVD.(R/L)JA.100	100	63	-	100	VN .. 16 04 ..	D07





SVPB R/L 117.5°/35°



Bestell-Nr./ Order number	HSK T	f	D1 min.	A	Wendeplatte/ Insert	Ersatzteile/ Spareparts
HA4.KVF.(R/L)PA.055-HP	40	27	50	55	VB .. 16 04 ..	S07
HA6.KVF.(R/L)PA.070-HP	63	45	80	70	VB .. 16 04 ..	S07
HA0.KVF.(R/L)PA.100	100	63	120	100	VB .. 16 04 ..	S07

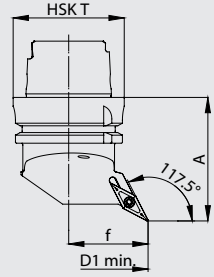

SVPC R/L 117.5°/35°



Bestell-Nr./ Order number	HSK T	f	D1 min.	A	Wendeplatte/ Insert	Ersatzteile/ Spareparts
HA4.KVA.(R/L)PA.055	40	27	50	55	VC .. 11 03 ..	S10
HA4.KVB.(R/L)PA.055	40	27	50	55	VC .. 16 04 ..	S07
HA6.KVB.(R/L)PA.070-HP	63	45	80	70	VC .. 16 04 ..	S07
HA0.KVB.(R/L)PA.100	100	63	120	100	VC .. 16 04 ..	S07

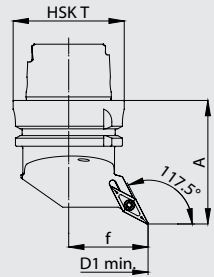

DVPN R/L 117.5°/35°



Bestell-Nr./ Order number	HSK T	f	D1 min.	A	Wendeplatte/ Insert	Ersatzteile/ Spareparts
HA4.KVD.(R/L)PA.055	40	27	-	55	VN .. 16 04 ..	D07
HA6.KVD.(R/L)PA.070	63	45	80	70	VN .. 16 04 ..	D07
HA0.KVD.(R/L)PA.100	100	63	120	100	VN .. 16 04 ..	D07

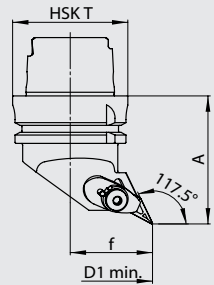

SSBC R/L 90°/75°



Bestell-Nr./ Order number	HSK T	f	D1 min.	A	Wendeplatte/ Insert	Ersatzteile/ Spareparts
HA4.KSB.(R/L)BA.055	40	27	-	55	SC .. 12 04 ..	S09
HA6.KSB.(R/L)BA.070	63	45	-	70	SC .. 12 04 ..	S09
HA0.KSB.(R/L)BA.100	100	63	-	100	SC .. 12 04 ..	S09

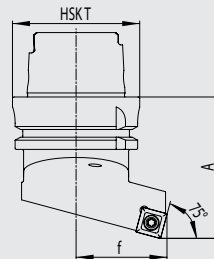

PSBN R/L 90°/75°



Bestell-Nr./ Order number	HSK T	f	D1 min.	A	Wendeplatte/ Insert	Ersatzteile/ Spareparts
HA4.PSD.(R/L)BA.055	40	27	-	55	SN .. 12 04 ..	P07
HA6.PSD.(R/L)BA.070	63	45	-	70	SN .. 12 04 ..	P07
HA0.PSD.(R/L)BA.100	100	63	-	100	SN .. 12 04 ..	P07

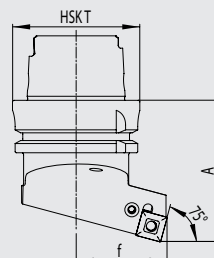

SSSC R/L 90°/45°

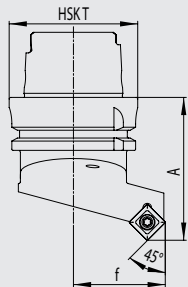

Bestell-Nr. / Order number	HSK T	f	D1 min.	A	Wendeplatte/ Insert	Ersatzteile/ Spareparts
HA4.KSB.(R/L)SA.055	40	27	-	55	SC .. 12 04 ..	S09
HA6.KSB.(R/L)SA.070	63	45	-	70	SC .. 12 04 ..	S09
HA0.KSB.(R/L)SA.100	100	63	-	100	SC .. 12 04 ..	S09



PSSN R/L 90°/45°

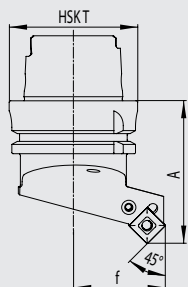

Bestell-Nr. / Order number	HSK T	f	D1 min.	A	Wendeplatte/ Insert	Ersatzteile/ Spareparts
HA4.PSD.(R/L)SA.055	40	27	-	55	SN .. 12 04 ..	P07
HA6.PSD.(R/L)SA.070	63	45	-	70	SN .. 12 04 ..	P07
HA0.PSD.(R/L)SA.100	100	63	-	100	SN .. 12 04 ..	P07
HA0.PSE.(R/L)SA.100	100	63	-	100	SN .. 15 06 ..	P10



SCMC N 50°/80°/50°

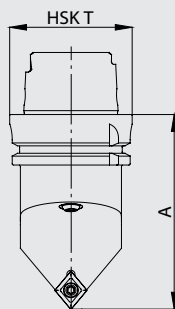

Bestell-Nr. / Order number	HSK T	A	Wendeplatte/ Insert	Ersatzteile/ Spareparts
HA4.KCB.NMA.080-HP	40	80	CC .. 09 T3 ..	S05 HP ready
HA4.KCC.NMA.080	40	80	CC .. 12 04 ..	S01
HA6.KCC.NMA.100-HP	63	100	CC .. 12 04 ..	S01 HP ready
HA6.KCC.NMA.130-HP	63	130	CC .. 12 04 ..	S01 HP ready
HA0.KCC.NMA.125-HP	100	125	CC .. 12 04 ..	S01 HP ready



PCMN N 50°/80°/50°

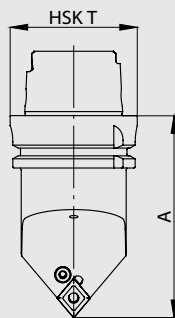

Bestell-Nr. / Order number	HSK T	A	Wendeplatte/ Insert	Ersatzteile/ Spareparts
HA4.PCD.NMA.080	40	80	CN .. 12 04 ..	P01
HA6.PCD.NMA.100-HP	63	100	CN .. 12 04 ..	P01 HP ready
HA6.PCD.NMA.130-HP	63	130	CN .. 12 04 ..	P01 HP ready
HA6.PCE.NMA.100-HP	63	100	CN .. 16 06 ..	P02 HP ready
HA6.PCE.NMA.130-HP	63	130	CN .. 16 06 ..	P02 HP ready
HA0.PCD.NMA.125	100	125	CN .. 12 04 ..	P01
HA0.PCE.NMA.125	100	125	CN .. 16 06 ..	P02



Bestell-Nr. /
Order number

CHP.PCX.000.022



- Hochleistungskühlmittel Set beinhaltet:
 - HP Düse
 - O-Ring

- High performance coolant set included:
 - HP coolant nozzle
 - O-ring



SDNC N 62.5°/55°/62.5°



Bestell-Nr. / Order number	HSK T	A	Wendeplatte/ Insert	Ersatzteile/ Spareparts
HA4.KDB.NNA.080-HP	40	80	DC .. 11 T3 ..	S05
HA6.KDB.NNA.100-HP	63	100	DC .. 11 T3 ..	S05
HA6.KDB.NNA.130-HP	63	130	DC .. 11 T3 ..	S05
HA0.KDB.NNA.125-HP	100	125	DC .. 11 T3 ..	S05

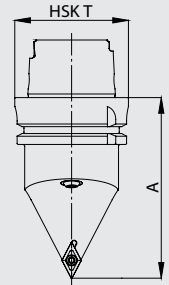

PDNN N 62.5°/55°/62.5°



Bestell-Nr. / Order number	HSK T	A	Wendeplatte/ Insert	Ersatzteile/ Spareparts
HA4.PDF.NNA.080-HP	40	80	DN .. 15 06 .. *	P06
HA6.PDF.NNA.100-HP	63	100	DN .. 15 06 .. *	P06
HA6.PDF.NNA.130-HP	63	130	DN .. 15 06 .. *	P06
HA0.PDF.NNA.125-HP	100	125	DN .. 15 06 .. *	P06

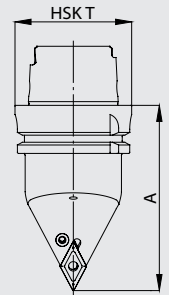

SVVB N 72.5°/35°/72.5°



Bestell-Nr. / Order number	HSK T	A	Wendeplatte/ Insert	Ersatzteile/ Spareparts
HA4.KVF.NVA.080-HP	40	80	VB .. 16 04 ..	S07
HA6.KVF.NVA.100-HP	63	100	VB .. 16 04 ..	S07
HA6.KVF.NVA.130-HP	63	130	VB .. 16 04 ..	S07
HA0.KVF.NVA.125	100	125	VB .. 16 04 ..	S07

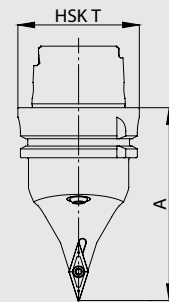

SVVC N 72.5°/35°/72.5°

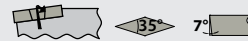

Bestell-Nr. / Order number	HSK T	A	Wendeplatte/ Insert	Ersatzteile/ Spareparts
HA4.KVA.NVA.055	40	55	VC .. 11 03 ..	S10
HA4.KVA.NVA.080	40	80	VC .. 11 03 ..	S10
HA4.KVB.NVA.080-HP	40	80	VC .. 16 04 ..	S07
HA6.KVB.NVA.100-HP	63	100	VC .. 16 04 ..	S07
HA6.KVB.NVA.130-HP	63	130	VC .. 16 04 ..	S07
HA0.KVB.NVA.125	100	125	VC .. 16 04 ..	S07

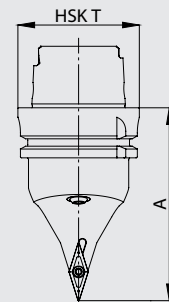

DVFN N 72.5°/35°/72.5°

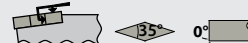

Bestell-Nr. / Order number	HSK T	A	Wendeplatten/ Inserts	Ersatzteile/ Spareparts
HA4.KVD.NVA.080	40	80	VN .. 16 04 ..	D08
HA6.KVD.NVA.100	63	100	VN .. 16 04 ..	D08
HA6.KVD.NVA.130	63	130	VN .. 16 04 ..	D08
HA0.KVD.NVA.125	100	125	VN .. 16 04 ..	D08
HA0.KVD.NVA.180	100	180	VN .. 16 04 ..	D08

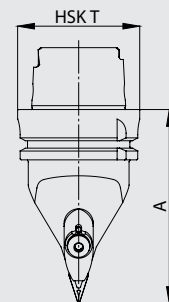

* DN .. 15 04 .. möglich mit Unterlegplatte WDF.ER2.101.004

* DN .. 15 04 .. possible with tip pad WDF.ER2.101.004

PDMN L 48° (93°)/55°

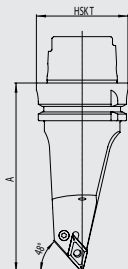

Bestell-Nr. / Order number	HSK T	A	Wendeplatte/ Insert	Ersatzteile/ Spareparts
HA6.KDB.NXA.130	63	130	DC .. 11 T3 ..	S05
HA6.KDB.NXA.150	63	150	DC .. 11 T3 ..	S05
HA6.PDF.NXA.130-HP	63	130	DN .. 15 06 .. *	P06
HA0.PDF.NXA.125-HP	100	125	DN .. 15 06 .. *	P06



* DN .. 15 04 .. möglich mit
Unterlegplatte WDF.ER2.101.004

* DN .. 15 04 .. possible with tip pad
WDF.ER2.101.004

SVMB L 50° (95°)/35°

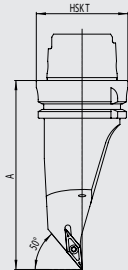

Bestell-Nr. / Order number	HSK T	A	Wendeplatte/ Insert	Ersatzteile/ Spareparts
HA6.KVF.NMA.130-HP	63	130	VB .. 16 04 ..	S07
HA0.KVF.NMA.125	100	125	VB .. 16 04 ..	S07



SVMC L 50° (95°)/35°

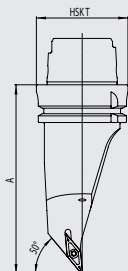

Bestell-Nr. / Order number	HSK T	A	Wendeplatte/ Insert	Ersatzteile/ Spareparts
HA6.KVB.NMA.130-HP	63	130	VC .. 16 04 ..	S07
HA6.KVB.NMA.130	63	130	VC .. 16 04 ..	S07



DVMN L 50° (95°)/35°

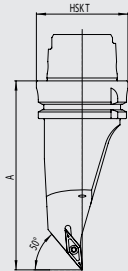
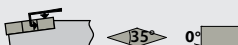

Bestell-Nr. / Order number	HSK T	A	Wendeplatte/ Insert	Ersatzteile/ Spareparts
HA6.KVD.NMA.130	63	130	VN .. 16 04 ..	D08



T DCM 50° (95°) / DDM 48° (93°)

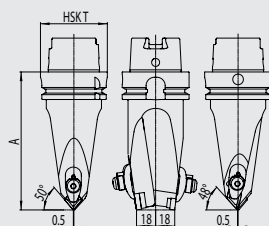

Bestell-Nr. / Order number	HSK T	A	Wendeplatte/ Insert	Ersatzteile/ Spareparts
HA6.KCD.NXD.130	63	130	DN .. 15 06 .. *	D06
			CN .. 12 04 ..	D01



* DN .. 15 04 .. möglich mit
Unterlegplatte WDF.ER2.101.004

* DN .. 15 04 .. possible with tip pad
WDF.ER2.101.004

NEW
HP
inside

Bohrstangen mit Wechselschneidköpfen

- für effiziente Drehbearbeitung
- optimale Kühlung durch ausgerichtete **High Pressure** Kühldüsen
- Mitnehmernuten am HSK nach ISO 12164-3

Boring bars with exchangeable cutting heads

- to turn efficiently
- optimal cooling by orientated **High Pressure** coolant nozzles
- drive key way of HSK shank according to ISO 12164-3

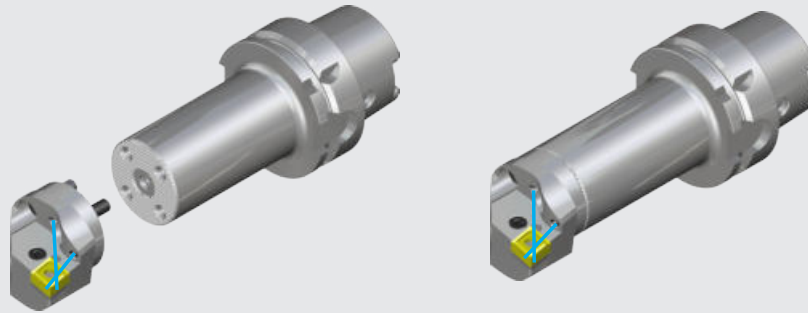

Bohrstangenschäfte

Boring bar shanks

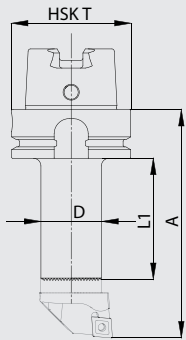

Bestell-Nr. / Order number	HSK T	D	A	L1
HA4.WK3.025.090	40	25	90	35
HA4.WK3.025.110	40	25	110	55
HA4.WK2.032.115	40	32	115	60
HA4.WK1.040.120	40	40	120	-
HA6.WK3.025.105	63	25	105	44
HA6.WK2.032.125	63	32	125	64
HA6.WK2.032.160	63	32	160	99
HA6.WK1.040.140	63	40	140	74
HA6.WK1.040.180	63	40	180	114
HA0.WK2.032.160	100	32	160	95
HA0.WK1.040.110	100	40	110	41
HA0.WK1.040.180	100	40	180	111

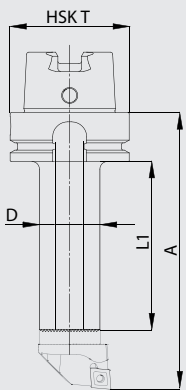

Schwingungsgedämpfte Bohrstangenschäfte

Damped boring bar shanks

Bestell-Nr. / Order number	HSK T	D	A	L1
HA6.WK3.025.150	63	25	150	89
HA6.WK2.032.185	63	32	185	124
HA6.WK1.040.225	63	40	225	159



Bohrstangenschäfte mit Zylinderschaft

Boring bar shanks with cylindrical shank

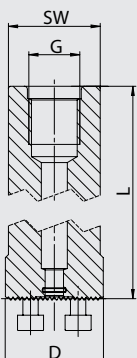

Bestell-Nr. / Order number	D	L	SW	G
U25.WK3.025.200	25	200	23	G1/4
U32.WK2.032.218	32	218	30	G3/8
U40.WK1.040.283	40	283	37	G1/2

- Anschlussgewinde für Innenkühlung
- 3Spanflächen

- with thread for inner coolant supply
- 3 clamping flats



Wechselschneidköpfe

Exchangeable cutting heads

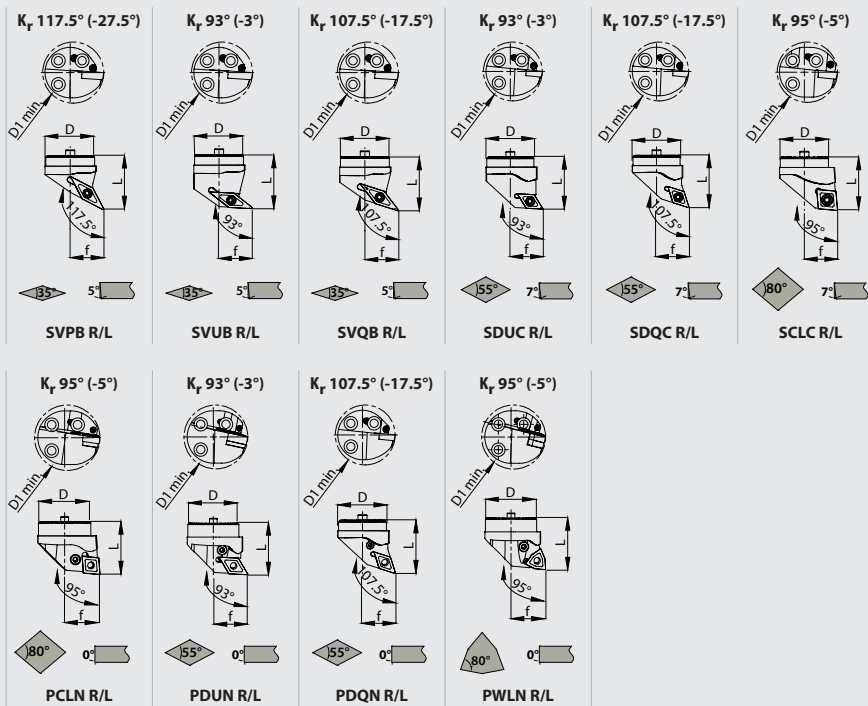

Typ/ Type	Bestell-Nr. / Order number	D	D1 min	f	L	Wendeplatte / Insert	Ersatzteile/ Spareparts
SVPB R/L	WK3.BVE.(R/L)PA.035	25	32	17	35	VB .. 11 03 ..	S05
SVPB R/L	WK2.BVF.(R/L)PB.035	32	40	22	35	VB .. 16 04 ..	S07
SVPB R/L	WK1.BVF.(R/L)PC.040	40	50	27	40	VB .. 16 04 ..	S07
SVUB R/L	WK3.BVE.(R/L)UA.035	25	32	17	35	VB .. 11 03 ..	S05
SVUB R/L	WK2.BVF.(R/L)UB.035	32	40	22	35	VB .. 16 04 ..	S07
SVUB R/L	WK1.BVF.(R/L)UC.040	40	50	27	40	VB .. 16 04 ..	S07
SVQB R/L	WK3.BVE.(R/L)QA.035	25	32	17	35	VB .. 11 03 ..	S05
SVQB R/L	WK2.BVF.(R/L)QB.035	32	40	22	35	VB .. 16 04 ..	S07
SVQB R/L	WK1.BVF.(R/L)QC.040	40	50	27	40	VB .. 16 04 ..	S07
SDUC R/L	WK3.BDB.(R/L)UA.035	25	32	17	35	DC .. 11 T3 ..	S05
SDUC R/L	WK2.BDB.(R/L)UB.035	32	40	22	35	DC .. 11 T3 ..	S05
SDUC R/L	WK1.BDB.(R/L)UC.040	40	50	27	40	DC .. 11 T3 ..	S05
SDQC R/L	WK3.BDB.(R/L)QA.035	25	32	17	35	DC .. 11 T3 ..	S05
SDQC R/L	WK2.BDB.(R/L)QB.035	32	40	22	35	DC .. 11 T3 ..	S05
SDQC R/L	WK1.BDB.(R/L)QC.040	40	50	27	40	DC .. 11 T3 ..	S05
SCLC R/L	WK3.BCC.(R/L)LA.035	25	32	17	35	CC .. 12 04 ..	S01
SCLC R/L	WK2.BCC.(R/L)LB.035	32	40	22	35	CC .. 12 04 ..	S01
SCLC R/L	WK1.BCC.(R/L)LC.040	40	50	27	40	CC .. 12 04 ..	S01
PCLN R/L	WK3.PCD.(R/L)LA.035	25	32	17	35	CN .. 12 04 ..	P01
PCLN R/L	WK2.PCD.(R/L)LB.035	32	40	22	35	CN .. 12 04 ..	P01
PCLN R/L	WK1.PCD.(R/L)LC.040	40	50	27	40	CN .. 12 04 ..	P01
PDUN R/L	WK3.PDE.(R/L)UA.035	25	32	17	35	DN .. 11 04 ..	P08
PDUN R/L	WK2.PDE.(R/L)UB.035	32	40	22	35	DN .. 11 04 ..	P08
PDUN R/L	WK1.PDE.(R/L)UC.040	40	50	27	40	DN .. 11 04 ..	P08
PDUN R/L	WK2.PDF.(R/L)UB.035	32	40	22	35	DN .. 15 06 ..	P05
PDUN R/L	WK1.PDF.(R/L)UC.040	40	50	27	40	DN .. 15 06 ..	P05
PDQN R/L	WK3.PDE.(R/L)QA.035	25	32	17	35	DN .. 11 04 ..	P08
PDQN R/L	WK2.PDE.(R/L)QB.035	32	40	22	35	DN .. 11 04 ..	P08
PDQN R/L	WK1.PDE.(R/L)QC.040	40	50	27	40	DN .. 11 04 ..	P08
PWLN R/L	WK2.PWE.(R/L)LB.035	32	40	22	35	WN .. 08 04 ..	P04
PWLN R/L	WK1.PWE.(R/L)LC.040	40	50	27	40	WN .. 08 04 ..	P04

Bohrstange

Boring bar

- für effiziente Drehbearbeitung
- optimale Kühlung durch ausgerichtete Kühldüse
- Mitnehmernuten am HSK nach ISO 12164-3

- to turn efficiently
- optimal cooling by adjustment cooling nozzle
- drive key way of HSK shank according to ISO 12164-3

SCLC R/L 95°/80°



Bestell-Nr. / Order number	HSK T	f	D	D1 min.	A	L	Wendeplatte / Insert	Ersatzteile/ Spareparts
HA4.BCC.(R/L)LA.110	40	17	25	32	110	90	CC .. 12 04 ..	S01
HA4.BCC.(R/L)LA.140	40	17	25	32	140	120	CC .. 12 04 ..	S01
HA6.BCC.(R/L)LB.125	63	22	32	40	125	99	CC .. 12 04 ..	S01
HA6.BCC.(R/L)LB.160	63	22	32	40	160	134	CC .. 12 04 ..	S01
HA6.BCC.(R/L)LC.140	63	27	40	50	140	114	CC .. 12 04 ..	S01
HA6.BCC.(R/L)LC.180	63	27	40	50	180	154	CC .. 12 04 ..	S01

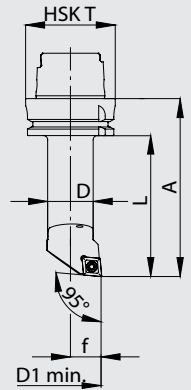

PCLN R/L 95°/80°



Bestell-Nr. / Order number	HSK T	f	D	D1 min.	A	L	Wendeplatte / Insert	Ersatzteile/ Spareparts
HA6.PCD.(R/L)LC.140	63	27	40	50	140	114	CN .. 12 04 ..	P01
HA6.PCD.(R/L)LC.180	63	27	40	50	180	154	CN .. 12 04 ..	P01
HA0.PCD.(R/L)LC.150	100	27	40	50	150	121	CN .. 12 04 ..	P01
HA0.PCD.(R/L)LC.200	100	27	40	50	200	171	CN .. 12 04 ..	P01
HA0.PCD.(R/L)LD.150	100	35	50	63	150	121	CN .. 12 04 ..	P01
HA0.PCD.(R/L)LD.200	100	35	50	63	200	171	CN .. 12 04 ..	P01

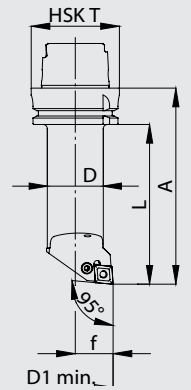

SDQC R/L 107.5°/55°



Bestell-Nr. / Order number	HSK T	f	D	D1 min.	A	L	Wendeplatte / Insert	Ersatzteile/ Spareparts
HA4.BDB.(R/L)LA.110	40	17	25	32	110	90	DC .. 11 T3 ..	S05
HA4.BDB.(R/L)LA.140	40	17	25	32	140	120	DC .. 11 T3 ..	S05
HA6.BDB.(R/L)QB.125	63	22	32	40	125	99	DC .. 11 T3 ..	S05
HA6.BDB.(R/L)QB.160	63	22	32	40	160	134	DC .. 11 T3 ..	S05
HA6.BDB.(R/L)QC.140	63	27	40	50	140	114	DC .. 11 T3 ..	S05
HA6.BDB.(R/L)QC.180	63	27	40	50	180	154	DC .. 11 T3 ..	S05

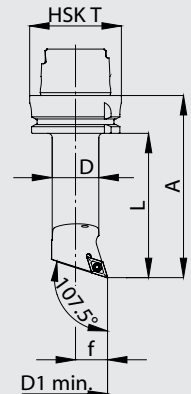

PDQN R/L 107.5°/55°



Bestell-Nr. / Order number	HSK T	f	D	D1 min.	A	L	Wendeplatte / Insert	Ersatzteile/ Spareparts
HA6.PDF.(R/L)QC.140	63	27	40	50	140	114	DN .. 15 06 ..*	P05
HA6.PDF.(R/L)QC.180	63	27	40	50	180	154	DN .. 15 06 ..*	P05
HA0.PDF.(R/L)QC.150	100	27	40	50	150	121	DN .. 15 06 ..*	P05
HA0.PDF.(R/L)QC.200	100	27	40	50	200	171	DN .. 15 06 ..*	P05
HA0.PDF.(R/L)QD.150	100	35	50	63	150	121	DN .. 15 06 ..*	P05
HA0.PDF.(R/L)QD.200	100	35	50	63	200	171	DN .. 15 06 ..*	P05

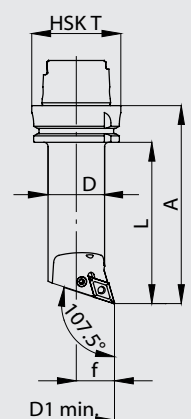

* DN .. 15 04 .. möglich mit Unterlegplatte WDF.ER2.101.004

* DN .. 15 04 .. possible with tip pad WDF.ER2.101.004

Bohrstangenhalter

Boring bar holder

- zum Halten von Bohrstäben
- Mitnehmernuten am HSK nach ISO 12164-3

- to clamp boring bars
- drive key way of HSK shank according to ISO 12164-3

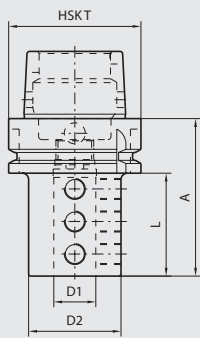

Bestell-Nr. / Order number	HSKT	D1	D2	A	L
HA4.B06.K01.055	40	6	34	55	35
HA4.B08.K01.055	40	8	34	55	35
HA4.B10.K01.055	40	10	34	55	35
HA4.B12.K01.055	40	12	36	55	35
HA4.B16.K01.070	40	16	40	70	50
HA4.B20.K01.085	40	20	44	85	65
HA6.B06.K01.060	63	6	34	60	34
HA6.B08.K01.060	63	8	34	60	34
HA6.B10.K01.060	63	10	34	60	34
HA6.B12.K01.060	63	12	36	60	34
HA6.B16.K01.075	63	16	40	75	49
HA6.B20.K01.075	63	20	44	75	49
HA6.B25.K01.075	63	25	50	75	49
HA6.B32.K01.090	63	32	56	90	64
HA6.B40.K01.090	63	40	63	90	64
HA0.B06.K01.070	100	6	34	70	41
HA0.B08.K01.070	100	8	34	70	41
HA0.B10.K01.070	100	10	34	70	41
HA0.B12.K01.070	100	12	36	70	41
HA0.B16.K01.085	100	16	40	85	56
HA0.B20.K01.085	100	20	44	85	56
HA0.B25.K01.085	100	25	50	85	56
HA0.B32.K01.100	100	32	56	100	71
HA0.B40.K01.100	100	40	63	100	71

Schwingungsgedämpfte Bohrstangenhalter mit Schlitz

Damped Boring bar holder with slot

- Mehr Stabilität und schwingungsdämpfende Wirkung durch Umschlingung der Bohrstäben
- Hochdruck Kugeldüse und Innenkühlung
- Mitnehmernuten am HSK nach ISO 12164-3

- More stability and vibration-damping effect by wrapping the boring bars
- High pressure ball nozzle and internal cooling
- drive key way of HSK shank according to ISO 12164-3

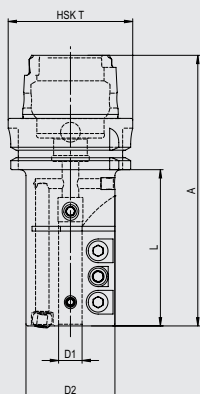

Bestell-Nr. / Order number	HSKT	D1	D2	A	L
HA6.B10.K21.105	63	10	45	105	65
HA6.B12.K21.105	63	12	45	105	65
HA6.B16.K21.105	63	16	45	105	75
HA6.B20.K21.105	63	20	55	105	80
HA6.B25.K21.105	63	25	55	105	80
HA6.B32.K21.105	63	32	65	105	80

Werkzeughalter für Wendepinnenbohrer

Toolholder for indexable insert drills

- zum Spannen von Zylinderschäften nach DIN 6595-1

- to clamp cylindrical shanks DIN 6595-1



Bestell-Nr. / Order number	HSK A	D1	D2	A
HA6.K20.K01.080	63	20	40	80
HA6.K25.K01.090	63	25	45	90
HA6.K32.K01.090	63	32	52	90
HA6.K40.K01.105	63	40	60	105
HA0.K20.K01.090	100	20	40	90
HA0.K25.K01.095	100	25	45	95
HA0.K32.K01.100	100	32	52	100
HA0.K40.K01.110	100	40	60	110

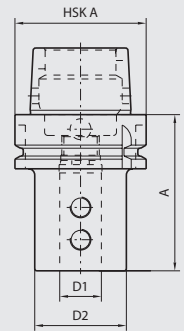

Abstechhalter radial

Cut-off block radial

Bestell-Nr. / Order number	HSKT	H	A	L	ØD
HA4.AM2.K11.075	40	26	75	70	100
HA6.AM3.K11.080	63	32	80	75	100
HA0.AM3.K11.085	100	32	85	80	100

- Kühlöse beidseitig Montierbar

- the coolant nozzle is mountable double sided

Stechschwert / cut-off blade

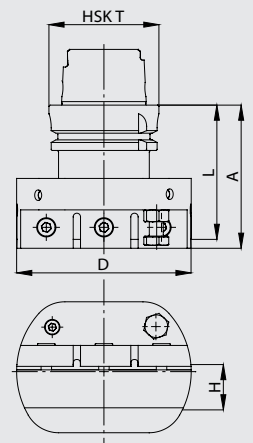
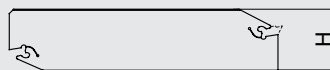

Abstechhalter axial

Cut-off block axial

Bestell-Nr. / Order number	HSKT	f	A	H	L	ØD	rechts/links right/left
HA6.AM3.K11.145	63	22	145	32	105	80	R
HA6.AM3.K12.145	63	22	145	32	105	80	L
HA0.AM3.K11.150	100	30	150	32	105	90	R
HA0.AM3.K12.150	100	30	150	32	105	90	L

Stechschwert / cut-off blade

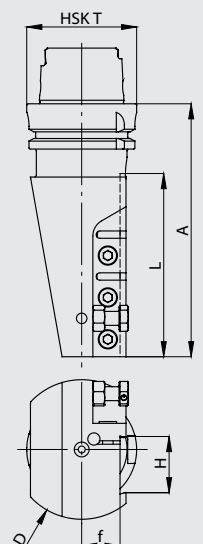
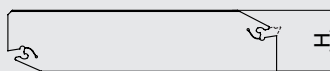

Aussengewinde radial

External thread radial

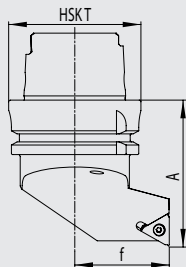

Bestell-Nr. / Order number	HSK T	f	D1 min.	A	R/L	Wendeplatte/ Insert	Ersatzteile/ Spareparts
HA4.KGB.RGR.055	40	27	-	55	R	16 ER	G01
HA4.KGB.LGR.055	40	27	-	55	L	16 EL	G02
HA6.KGB.RGR.070	63	45	-	70	R	16 ER	G01
HA6.KGB.LGR.070	63	45	-	70	L	16 EL	G02
HA0.KGB.RGR.100	100	63	-	100	R	16 ER	G01
HA0.KGB.LGR.100	100	63	-	100	L	16 EL	G02
HA0.KGC.RGR.100	100	63	-	100	R	22 ER	G05
HA0.KGC.LGR.100	100	63	-	100	L	22 EL	G06



Aussengewinde axial

External thread axial

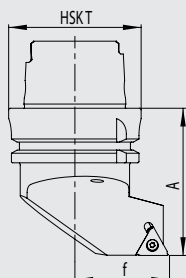

Bestell-Nr. / Order number	HSK T	f	D1 min.	A	R/L	Wendeplatte/ Insert	Ersatzteile/ Spareparts
HA4.KGB.RGA.055	40	27	-	55	R	16 EL	G03
HA4.KGB.LGA.055	40	27	-	55	L	16 ER	G04
HA6.KGB.RGA.070	63	45	-	70	R	16 EL	G03
HA6.KGB.LGA.070	63	45	-	70	L	16 ER	G04
HA0.KGB.RGA.100	100	63	-	100	R	16 EL	G03
HA0.KGB.LGA.100	100	63	-	100	L	16 ER	G04



Innengewinde

Internal thread

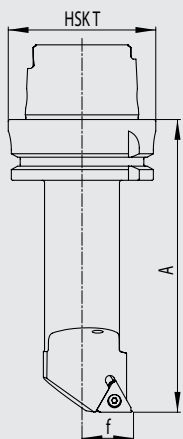

Bestell-Nr. / Order number	HSK T	f	D	D1 min.	A	L	Wendeplatte / Insert	Ersatzteile/ Spareparts
HA4.BGB.RGA.110	40	17	25	32	110	90	16 IL	G04
HA4.BGB.LGA.110	40	17	25	32	110	90	16 IR	G03
HA6.BGB.RGA.125	63	22	32	40	125	99	16 IL	G04
HA6.BGB.LGA.125	63	22	32	40	125	99	16 IR	G03
HA6.BGB.RGA.140	63	27	40	50	140	114	16 IL	G04
HA6.BGB.LGA.140	63	27	40	50	140	114	16 IR	G03
HA0.BGB.RGA.150	100	27	40	50	150	121	16 IL	G04
HA0.BGB.LGA.150	100	27	40	50	150	121	16 IR	G03



**Wechselschneidköpfe für
Innengewinde**

**Exchangeable cutting heads for
Internal thread**

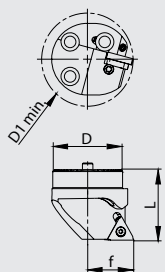

Bestell-Nr. / Order number	D	D1 min.	f	L	Wendeplatte / Insert	Ersatzteile/ Spareparts
WK3.BGB.RGA.035	25	32	17	35	16 IL	G04
WK3.BGB.LGA.035	25	32	17	35	16 IR	G03
WK2.BGB.RGB.035	32	40	22	35	16 IL	G04
WK2.BGB.LGB.035	32	40	22	35	16 IR	G03
WK1.BGB.RGC.040	40	50	27	40	16 IL	G04
WK1.BGB.LGC.040	40	50	27	40	16 IR	G03



• Bohrstangenschäfte siehe Seite 13

• Boring bar shanks page 13

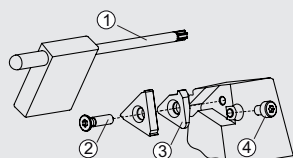

Für Gewindehalter For thread tool	Typ/ Type	Bestell-Nr. / Order number	① Torx-Schlüssel/ Torx driver	② Bestell-Nr. / Order number Torx-Schraube Torx screw	③ Bestell-Nr. / Order number Zwischenlage/ Tip pad	④ Bestell-Nr. / Order number Schraube/ Screw
xxx.KGB.RGR.xxx	G01	WGB.ER1.001.000		WGB.ER2.001.012 (2.0 Nm)	WGB.ER2.102.003	WGB.ER3.001.007 (2.0 Nm)
xxx.KGB.LGR.xxx	G02	WGB.ER1.001.000		WGB.ER2.001.012 (2.0 Nm)	WGB.ER2.101.003	WGB.ER3.001.007 (2.0 Nm)
xxx.xGB.RGA.xxx	G03	WGB.ER1.001.000		WGB.ER2.001.012 (2.0 Nm)	WGB.ER2.101.003	WGB.ER3.001.007 (2.0 Nm)
xxx.xGB.LGA.xxx	G04	WGB.ER1.001.000		WGB.ER2.001.012 (2.0 Nm)	WGB.ER2.102.003	WGB.ER3.001.007 (2.0 Nm)



Werkzeughalter axial

Tool holder axial

Bestell-Nr. / Order number	HSK T	B	Vierkant Square	A	L	ØD
HA4.V16.(R/L)11.080	40	30	16x16	80	40	80
HA4.V20.(R/L)11.080	40	30	20x20	80	45	80
HA6.V20.(R/L)11.090	63	30	20x20	90	45	80
HA6.V25.(R/L)11.100	63	40	25x25	100	58	102
HA0.V25.(R/L)11.125	100	50	25x25	125	80	122
HA0.V32.(R/L)11.125	100	50	32x32	125	80	122

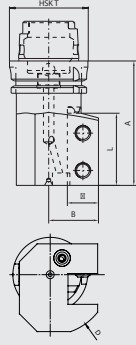

Werkzeughalter axial doppelt

Tool holder axial double

Bestell-Nr. / Order number	HSK T	B	Vierkant Square	A	L	ØD
HA4.V20.R21.080	40	30	20x20	80	45	80
HA6.V20.R21.090	63	30	20x20	90	45	80
HA6.V25.R21.100	63	40	25x25	100	58	102
HA0.V25.R21.125	100	50	25x25	125	80	122
HA0.V32.R21.125	100	50	32x32	125	80	122

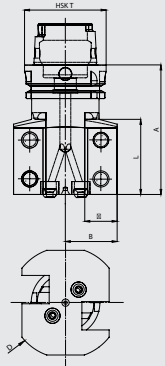

Werkzeughalter axial dreifach

Tool holder axial triple

Bestell-Nr. / Order number	HSK T	B	Vierkant Square	A	L	ØD
HA6.V20.R31.090	63	30	20x20	90	45	90
HA6.V25.R31.100	63	40	25x25	100	58	102
HA0.V25.R31.125	100	50	25x25	125	80	122

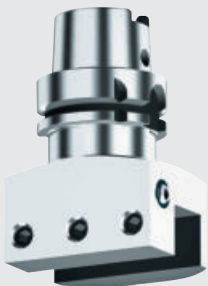
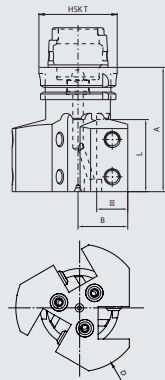

Werkzeughalter radial

Tool holder radial

Bestell-Nr. / Order number	HSK T	B	Vierkant Square	A	ØD
HA4.V20.N11.075	40	30	20x20	75	80
HA6.V20.N11.090	63	30	20x20	90	80
HA6.V25.N11.090	63	40	25x25	90	102
HA0.V25.N11.100	100	50	25x25	100	122
HA0.V32.N11.100	100	50	32x32	100	122

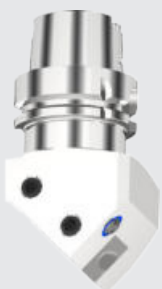
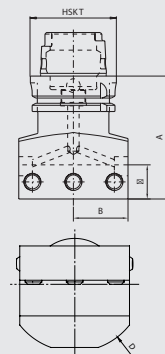

Werkzeughalter diagonal 45°

Tool holder diagonal 45°

Bestell-Nr. / Order number	HSK T	f	Vierkant Square	A	ØD
HA4.V20.R12.080	40	5	20x20	80	80
HA4.V20.L12.080	40	5	20x20	80	80
HA6.V20.R12.100	63	5	20x20	100	80
HA6.V20.L12.100	63	5	20x20	100	80
HA6.V25.R12.100	63	5	25x25	100	102
HA6.V25.L12.100	63	5	25x25	100	102
HA0.V25.R12.125	100	5	25x25	125	122
HA0.V25.L12.125	100	5	25x25	125	122

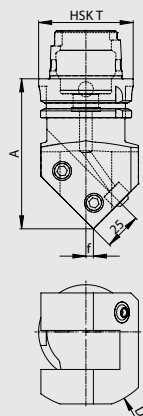

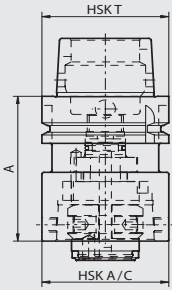

HSK-Verlängerung

- Mitnehmernuten am HSK nach ISO 12164-3

HSK-Extension

- drive key way of HSK shank according to ISO 12164-3

Bestell-Nr. / Order number	HSK T	HSK A/C	A
HA4.HA4.K01.060	40	40	60
HA4.HA4.K01.080	40	40	80
HA6.HA6.K01.080	63	63	80
HA6.HA6.K01.120	63	63	120
HA0.HA0.K01.125	100	100	125
HA0.HA0.K01.160	100	100	160
HA0.HA0.K01.200	100	100	200

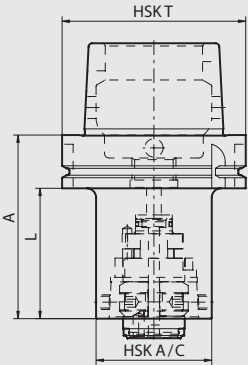

HSK-Reduktion

- Mitnehmernuten am HSK nach ISO 12164-3

HSK-Reduction

- drive key way of HSK shank according to ISO 12164-3

Bestell-Nr. / Order number	HSK T	HSK A/C	A	L
HA6.HA4.K01.070	63	40	70	44
HA0.HA4.K01.080	100	40	80	51
HA0.HA6.K01.100	100	63	100	71



Ersatzteile / Spareparts	Bestell-Nr. / Order number	Bestell-Nr. / Order number	Bestell-Nr. / Order number
	Spannpatrone / Clamping cartridge	Verschlusschraube / Drive bolt	Dichtring / Sealing ring
xxx.HA4.xxx.xxx	HA4.ER1.001.000	HA4.ER2.001.005	HA4.ER4.004.006
xxx.HA6.xxx.xxx	HA6.ER1.001.000	HA6.ER2.001.007	HA6.ER4.004.008
xxx.HA0.xxx.xxx	HA0.ER1.001.000	HA0.ER2.001.000	HA0.ER4.004.010

Spanneinheit HSK

Clamping unit HSK

- zur Montage in Revolver oder Revolveraufbauten
- Spitzenhöhe einstellbar über Excenter
- innere Kühlmitteldurchführung

- for use in turret or clamping unit holder
- center height adjustable with an excenter
- inner coolant supply

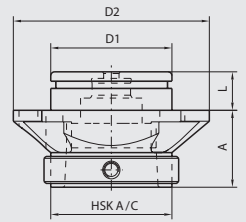
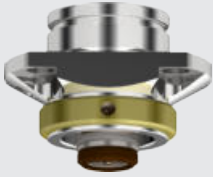

Bestell-Nr. / Order number	HSK A/C	D1	D2	A	L
U40.HA4.001.025	40	40	68	25	17
U63.HA6.001.040	63	63	102	40	20
U10.HA0.001.060	100	100	165	60	30

Ersatzteile / Spareparts	Bestell-Nr. / Order number	Bestell-Nr. / Order number	Bestell-Nr. / Order number
	Spannpatrone / Clamping cartridge	Verschlusschraube / Drive bolt	Dichtring / Sealing ring
xxx.HA4.xxx.xxx	HA4.ER1.001.000	HA4.ER2.001.005	HA4.ER4.004.006
xxx.HA6.xxx.xxx	HA6.ER1.001.000	HA6.ER2.001.007	HA6.ER4.004.008
xxx.HA0.xxx.xxx	HA0.ER1.001.000	HA0.ER2.001.000	HA0.ER4.004.010

Trennstellenverschluss

Blanking plug



Bestell-Nr. / Order number	HSK A	D1	L
HA4.000.001.020	40	40	20
HA6.000.001.026	63	63	26
HA0.000.001.029	100	100	29

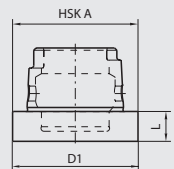

Rohling

Blank

- HSK-T / ISO 12164-3
- Einsatzgehärtet 48HRc / 0.8mm tief

- HSK-T / ISO 12164-3
- case-hardened 48HRc depth 0.8mm



Bestell-Nr. / Order number	HSK T	D1	A	L	L1
HA4.Ro4.001.055	40	54	55	35	20
HA6.Ro5.001.100	63	52	100	-	58
HA6.Ro9.001.070	63	90	70	44	28
HA6.Ro6.001.200	63	63	200	174	158
HA0.Ro8.001.125	100	87	125	-	80
HA0.Ro0.001.090	100	130	90	61	45
HA0.Ro0.001.250	100	100	250	221	205

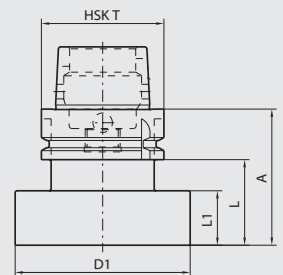

Ersatzteile / Zubehör

Spare parts / Accessories

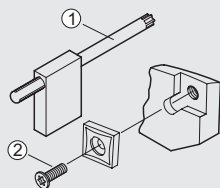

Für Klemmhalter/
Bohrstange
For turning tool/
boring bar

Typ/
Type

Bestell-Nr. / ①
Order number

Bestell-Nr. / ②
Order number

Torx-Schlüssel/
Torx driver

Torx-Schraube
Torx screw (Nm)

xxx.xCC.xxx.xxx	S01	WCC.ER1.001.000	WCC.ER2.001.010 (5.0 Nm)
xxx.xCD.xxx.xxx	S02	WCC.ER1.001.000	WCC.ER2.001.010 (5.0 Nm)
xxx.xCE.xxx.xxx	S03	WCE.ER1.001.000	WCE.ER2.001.012 (5.0 Nm)
xxx.xWE.xxx.xxx	S04	WCC.ER1.001.000	WCC.ER2.001.010 (5.0 Nm)
xxx.xDB.xxx.xxx	S05	WCB.ER1.001.000	WCB.ER2.001.009 (3.0 Nm)
xxx.xDF.xxx.xxx	S06	WCC.ER1.001.000	WCC.ER2.001.010 (5.0 Nm)
xxx.xVF/VB.xxx.xxx	S07	WCB.ER1.001.000	WCB.ER2.001.009 (3.0 Nm)
xxx.xVD.xxx.xxx	S08	WCB.ER1.001.000	WCB.ER2.001.009 (3.0 Nm)
xxx.xSB.xxx.xxx	S09	WCC.ER1.001.000	WCC.ER2.001.010 (5.0 Nm)
xxx.xVE/VA.xxx.xxx	S10	WCA.ER1.001.000	WCA.ER2.001.006 (0.9 Nm)

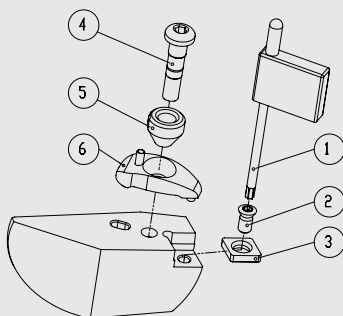

Für Klemmhalter/
Bohrstange
For turning tool/
boring bar

Typ/
Type

Bestell-Nr. / ③
Order number

Bestell-Nr. / ④
Order number

Bestell-Nr. / ⑤
Order number

Bestell-Nr. / ⑥
Order number

Zwischenlage/
Tip pad

Spannschraube/
Clamping screw (Nm)

Düsenring/
Nozzle ring

Spannpratze/
Clamping short

xxx.xCD.xxx.xxx	D01	WCD.ER2.101.003	WCC.ER4.103.032 (10 Nm)	WCC.ER5.102.012	WCC.ER3.102.024
xxx.KCE.R/Lxx.xxx	D02	WCE.ER2.101.004	WCC.ER4.103.032 (10 Nm)	WCC.ER5.102.012	WCC.ER3.102.024
xxx.KCE.Nxx.xxx	D03	WCE.ER2.101.004	WCC.ER4.103.032 (10 Nm)	WCC.ER5.102.012	WCC.ER3.102.029
xxx.KWE.R/Lxx.xxx	D04	WWE.ER2.101.004	WCC.ER4.103.032 (10 Nm)	WCC.ER5.102.012	WCC.ER3.102.024
xxx.xDF.R/Lxx.xxx	D05	WDF.ER2.101.003	WCC.ER4.103.032 (10 Nm)	WCC.ER5.102.012	WCC.ER3.102.024
xxx.KDF.Nxx.xxx	D06	WDF.ER2.101.003	WCC.ER4.103.032 (10 Nm)	WCC.ER5.102.012	WCC.ER3.102.029
xxx.xVD.R/Lxx.xxx	D07	WVD.ER2.101.003	WCC.ER4.103.032 (10 Nm)	WCC.ER5.102.012	WCC.ER3.102.024
xxx.KVD.Nxx.xxx	D08	WVD.ER2.101.003	WCC.ER4.103.032 (10 Nm)	WCC.ER5.102.012	WCC.ER3.102.029
xxx.KSD.R/Lxx.xxx	D09	WSD.ER2.101.003	WCC.ER4.103.032 (10 Nm)	WCC.ER5.102.012	WCC.ER3.102.024

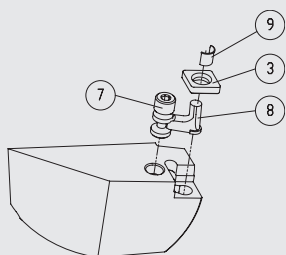

Für Klemmhalter/
Bohrstange
For turning tool/
boring bar

Typ/
Type

Bestell-Nr. / ③
Order number

Bestell-Nr. / ⑦
Order number (Nm)

Bestell-Nr. / ⑧
Order number

Bestell-Nr. / ⑨
Order number

Zwischenlage/
Tip pad

Spannschraube/
Clamping screw

Kniehebel/
Lever

Rohrstift/
Hollow pin

xxx.PCD.xxx.xxx	P01	WCD.ER2.101.003	WCD.ER4.101.017 (5.0 Nm)	WCD.ER3.101.000	WCD.ER1.101.000
xxx.PCE.R/Lxx.xxx	P02	WCE.ER2.101.004	WCE.ER4.101.004 (5.0 Nm)	WCE.ER3.101.000	WCE.ER1.101.000
xxx.PCE.Nxx.xxx	P03	WCE.ER2.101.004	WCE.ER4.101.004 (5.0 Nm)	WCE.ER3.101.000	WCE.ER1.101.000
xxx.PWE.R/Lxx.xxx	P04	WWE.ER2.101.004	WCD.ER4.101.017 (5.0 Nm)	WDF.ER3.101.000	WCD.ER1.101.000
xxx.PDF.R/Lxx.xxx	P05	WDF.ER2.101.003	WCD.ER4.101.017 (5.0 Nm)	WDF.ER3.101.000	WCD.ER1.101.000
xxx.PDF.Nxx.xxx	P06	WDF.ER2.101.003	WCD.ER4.101.017 (5.0 Nm)	WDF.ER3.101.000	WCD.ER1.101.000
xxx.PSD.R/Lxx.xxx	P07	WSD.ER2.101.003	WCD.ER4.101.017 (5.0 Nm)	WCD.ER3.101.000	WCD.ER1.101.000
xxx.PDE.xxx.xxx.xxx	P08	WDE.ER2.101.003	WDE.ER4.101.017 (5.0 Nm)	WDE.ER3.101.000	WDE.ER1.101.000
xxx.PCF.xxx.xxx	P09	WCF.ER2.101.000	WCF.ER4.101.027 (9.0 Nm)	WCF.ER3.101.000	WCF.ER1.101.000
xxx.PSE.xxx.xxx	P10	WSE.ER2.101.004	WCE.ER4.101.004 (5.0 Nm)	WCE.ER3.101.000	WCE.ER1.101.000

Für Werkzeughalter/
Für Bohrstangenhalter
For tool holder/
For boring bar holder

Bestell-Nr. /
Order number

Klemmschraube/
Clamping screw (Nm)

Dimension

xxx.V20.xxx.xxx	ERU.GS6.001.018 (15.0 Nm)	M10 x 18
xxx.V25.xxx.xxx	ERU.GS7.001.025 (20.0 Nm)	M12 x 25
xxx.B06.xxx.xxx	ERU.GS4.001.010 (5.0 Nm)	M 6 x 10
xxx.B08...B12.xxx.xxx	ERU.GS5.001.010 (10.0 Nm)	M 8 x 10
xxx.B16...B40.xxx.xxx	ERU.GS6.001.012 (15.0 Nm)	M10 x 12



HSK Werkzeug- aufnahmen Toolholders



SWISS+TOOLS

Swiss Tool Systems AG / Wydenstrasse 28 / CH - 8575 Bürglen
Phone +41 (0)71 634 85 20 / Fax +41 (0)71 634 85 29 / www.swisstools.org

Cool-Jet für Schrumpf- und Weldonfutter

Das Cool-Jet Kühlsystem besteht aus zwei Aussenkühlbohrungen. Die Bohrungen sind leicht zum Werkzeugzentrum geneigt damit der Kühlmittelstrahl nicht von der Fliehkraft abgelenkt wird. Die Bohrungen können mit Gewindestiften verschlossen werden.

(Alle Schrumpf- und Weldonfutter mit Cool-Jet werden verschlossen geliefert)

HIT

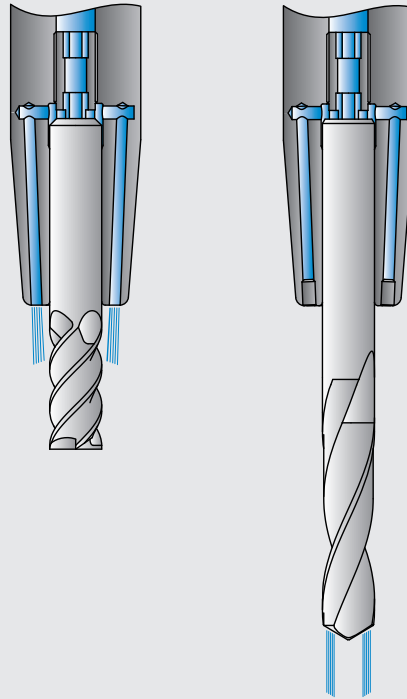

Cool-Jet for heat shrink chuck and weldon adapter

The key feature of the Cool-Jet system are two exterior cooling holes. The holes are directed to the tool center to avoid the deflection of the coolant jet by centrifugal force. The holes are lockable by using set screws.

(All heat shrink chucks and weldon adapters with cool-jet are locked when delivered)

Fräsdorne mit Differentialschraube und Cool-Jet

Messerköpfe, gespannt auf unseren Fräsdornen mit Cool-Jet, werden effizient mit Kühlmittel versorgt. Zum Einen über die Innenkühlung des Messerkopfes und zum Anderen über unsere Differentialschraube.

Milling arbors with differential screw and cool-jet

Milling cutters clamped on our milling arbors with cool-jet are cooled efficiently. On the one hand by the interior cooling through the milling cutter and on the other hand by our differential screw.

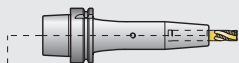
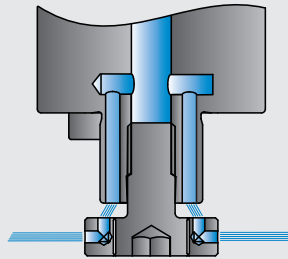

Schrumpffutter / Heat shrink Chuck
Seite / page 3-5

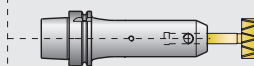

Flächenspannfutter / End mill adapter Weldon
Seite / page 6-7

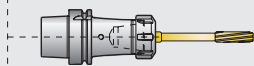

Spannzangenfutter / Collet Chuck
Seite / page 8

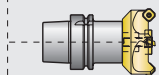

Fräsdorn / Milling arbor
Seite / page 9

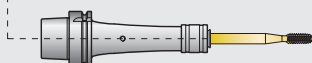

Gewindeschneidfutter / Tapping chuck
Seite / page 10

Schrumpffutter Typ S

Heat shrink chuck type S

- Standardausführung für hohe Klemmkraft
- für HM- und HSS-Werkzeuge
- Schafttoleranz h6
- Rundlaufgenauigkeit 3 µm
- Aufnahmen feingewuchtet
G 2.5/25000 U/min
- 2 Cool-Jet Bohrungen (verschlussbar)
- axiale Längenverstellung

- standard design for a better clamping force
- for solid carbide and high speed steel tools
- shank tolerance h6
- true running 3 µm
- fine balanced toolholders
G 2.5/25000 r/min
- 2 Cool-Jet holes (lockable)
- axial adjustment

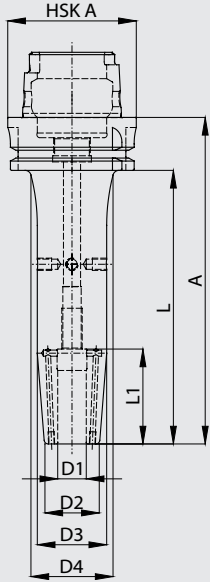

Bestell-Nr. / Order number	HSK A	D1	D2	D3	D4	A	L	L1
HA6.S06.K21.080	63	6	21	26	-	80	54	36
HA6.S06.K21.130	63	6	21	27	34	130	104	36
HA6.S06.K21.160	63	6	21	27	34	160	134	36
HA6.S08.K21.080	63	8	21	26	-	80	54	36
HA6.S08.K21.130	63	8	21	27	34	130	104	36
HA6.S08.K21.160	63	8	21	27	34	160	134	36
HA6.S10.K21.085	63	10	24	30	-	85	59	41
HA6.S10.K21.130	63	10	24	32	39	130	104	41
HA6.S10.K21.160	63	10	24	32	39	160	134	41
HA6.S12.K21.090	63	12	24	30	-	90	64	46
HA6.S12.K21.130	63	12	24	32	39	130	104	46
HA6.S12.K21.160	63	12	24	32	39	160	134	46
HA6.S14.K21.090	63	14	27	34	-	90	64	46
HA6.S14.K21.130	63	14	27	34	41	130	104	46
HA6.S14.K21.160	63	14	27	34	41	160	134	46
HA6.S16.K21.095	63	16	27	34	-	95	69	49
HA6.S16.K21.130	63	16	27	34	41	130	104	49
HA6.S16.K21.160	63	16	27	34	41	160	134	49
HA6.S18.K21.095	63	18	33	41	-	95	69	49
HA6.S18.K21.130	63	18	33	41	48	130	104	49
HA6.S18.K21.160	63	18	33	41	48	160	134	49
HA6.S20.K21.100	63	20	33	41	-	100	74	51
HA6.S20.K21.130	63	20	33	41	48	130	104	51
HA6.S20.K21.160	63	20	33	41	48	160	134	51
HA6.S25.K21.115	63	25	44	52	-	115	89	57
HA6.S25.K21.160	63	25	44	52	-	160	134	57
HA6.S32.K21.120	63	32	44	52	-	120	94	61



Ersatzteile / Zubehör

Spare parts / Accessories

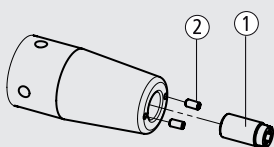

Für Schrumpffutter / For heat shrink chuck	Bestell-Nr. / Order number	Dimension	Bestell-Nr. / Order number	Dimension
	Anschlagschraube / Stop screw	①	Cool-Jet Verschlusschraube/ Screw plug	②
xxx.S06.xxx.xxx	ERU.AN1.K01.014	M 5 x 14	ERU.CJ2.001.006	M 3 x 6
xxx.S08.xxx.xxx	ERU.AN2.K01.016	M 6 x 16	ERU.CJ2.001.006	M 3 x 6
xxx.S10.xxx.xxx	ERU.AN3.K01.020	M 8 x 1 x 16	ERU.CJ2.001.006	M 3 x 6
xxx.S12...S14.xxx.xxx	ERU.AN4.K01.020	M10 x 1 x 20	ERU.CJ2.001.006	M 3 x 6
xxx.S16...S20.xxx.xxx	ERU.AN5.K01.020	M12 x 1 x 20	ERU.CJ2.001.006	M 3 x 6
xxx.S25...S50.xxx.xxx	ERU.AN5.K01.020	M12 x 1 x 20	ERU.CJ3.001.008	M 4 x 8

Schrumpffutter Typ S

Heat shrink chuck type S

- Standardausführung für hohe Klemmkraft
- für HM- und HSS-Werkzeuge
- Schafttoleranz h6
- Rundlaufgenauigkeit 3 µm
- Aufnahmen feingewuchtet
G 2.5/25000 U/min
- 2 Cool-Jet Bohrungen (verschlussbar)
- axiale Längenverstellung

- standard design for a better clamping force
- for solid carbide and high speed steel tools
- shank tolerance h6
- true running 3 µm
- fine balanced toolholders
G 2.5/25000 r/min
- 2 Cool-Jet holes (lockable)
- axial adjustment



Bestell-Nr. / Order number	HSK A	D1	D2	D3	D4	A	L	L1
HA0.S06.K21.085	100	6	21	26	-	85	56	36
HA0.S06.K21.130	100	6	21	30	-	130	101	36
HA0.S06.K21.160	100	6	21	30	39	160	131	36
HA0.S08.K21.085	100	8	21	26	-	85	56	36
HA0.S08.K21.130	100	8	21	30	-	130	101	36
HA0.S08.K21.160	100	8	21	30	39	160	131	36
HA0.S10.K21.090	100	10	24	30	-	90	61	41
HA0.S10.K21.130	100	10	24	34	-	130	101	41
HA0.S10.K21.160	100	10	24	34	43	160	131	41
HA0.S12.K21.095	100	12	24	30	-	95	66	46
HA0.S12.K21.130	100	12	24	34	-	130	101	46
HA0.S12.K21.160	100	12	24	34	43	160	131	46
HA0.S14.K21.095	100	14	27	34	-	95	66	46
HA0.S14.K21.130	100	14	27	37	--	130	101	46
HA0.S14.K21.160	100	14	27	37	46	160	131	46
HA0.S16.K21.100	100	16	27	34	-	100	71	49
HA0.S16.K21.130	100	16	27	37	-	130	101	49
HA0.S16.K21.160	100	16	27	37	46	160	131	49
HA0.S18.K21.100	100	18	33	41	-	100	71	49
HA0.S18.K21.130	100	18	33	44	-	130	101	49
HA0.S18.K21.160	100	18	33	44	53	160	131	49
HA0.S20.K21.105	100	20	33	41	-	105	76	51
HA0.S20.K21.130	100	20	33	44	-	130	101	51
HA0.S20.K21.160	100	20	33	44	53	160	131	51
HA0.S25.K21.115	100	25	44	53	-	115	86	57
HA0.S25.K21.160	100	25	44	56	65	160	131	57
HA0.S32.K21.120	100	32	44	53	-	120	91	61
HA0.S32.K21.160	100	32	44	56	65	160	131	61
HA0.S40.K21.125	100	40	60	70	-	125	96	71
HA0.S50.K21.130	100	50	69	79	-	130	101	82

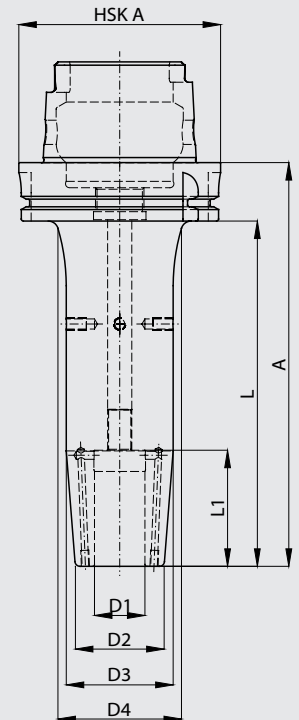

Schrumpffutter Typ L

- Standardausführung für hohe Klemmkraft
- für HM- und HSS-Werkzeuge
- Schafttoleranz h6
- Rundlaufgenauigkeit 3 µm
- Aufnahmen feingewuchtet G 2.5/25000 U/min
- axiale Längenverstellung

Heat shrink chuck type L

- standard design for a better clamping force
- for solid carbide and high speed steel tools
- shank tolerance h6
- true running 3 µm
- fine balanced toolholders G 2.5/25000 r/min
- axial adjustment

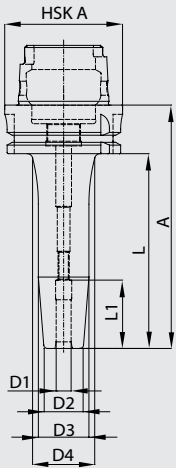

Bestell-Nr. / Order number	HSK A	D1	D2	D3	D4	A	L	L1
HA6.S06.K01.080	63	6	21	26	-	80	54	36
HA6.S08.K01.080	63	8	21	26	-	80	54	36
HA6.S10.K01.085	63	10	24	30	-	85	59	41
HA6.S12.K01.090	63	12	24	30	-	90	64	46
HA6.S14.K01.090	63	14	27	34	-	90	64	46
HA6.S16.K01.095	63	16	27	34	-	95	69	49
HA6.S18.K01.095	63	18	33	41	-	95	69	49
HA6.S20.K01.100	63	20	33	41	-	100	74	51
HA6.S25.K01.115	63	25	44	52	-	115	89	57
HA6.S32.K01.120	63	32	44	52	-	120	94	61



Schrumpffutter Typ M

- extrem schlanke Ausführung
- für HM- und HSS-Werkzeuge
- Schafttoleranz h6
- Rundlaufgenauigkeit 3 µm
- Aufnahmen feingewuchtet G 2.5/25000 U/min

Heat shrink chuck type M

- extreme slim design
- for solid carbide and high speed steel tools
- shank tolerance h6
- true running 3 µm
- fine balanced toolholders G 2.5/25000 r/min

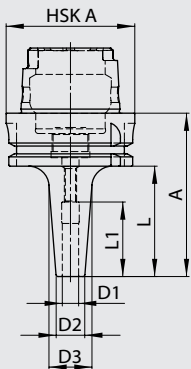

Bestell-Nr. / Order number	HSK A	D1	D2	D3	A	L	L1
HA6.S03.K01.080	63	3	10	17	80	54	9
HA6.S04.K01.080	63	4	10	17	80	54	12
HA6.S05.K01.080	63	5	10	17	80	54	15
HA6.S06.K05.080	63	6	14	21	80	54	36
HA6.S08.K05.080	63	8	14	21	80	54	36
HA6.S10.K05.080	63	10	20	28	80	54	41
HA6.S12.K05.080	63	12	20	28	80	54	46



Flächenspannfutter Weldon Typ S End mill adapter Weldon type S

- zur Aufnahme von Werkzeugen mit Zylinderschaft nach DIN 1835 B
- Aufnahme feingewuchtet
G 2.5/25 000 U/min
- 2 Cool-Jet Bohrungen
- to clamp tools with cylindrical shank according to DIN 1835 B
- fine balanced toolholders
G 2.5/25 000 r/min
- 2 Cool-Jet holes (lockable)

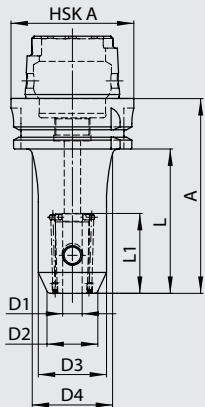

Bestell-Nr. / Ordernumber	HSKA	D1	D2	D3	D4	A	L	L1
HA6.W06.K21.065	63	6	17	30	-	65	39	37
HA6.W06.K21.100	63	6	17	30	36	100	74	37
HA6.W06.K21.130	63	6	17	30	36	130	104	37
HA6.W06.K21.160	63	6	17	30	36	160	134	37
HA6.W08.K21.065	63	8	20	32	-	65	39	37
HA6.W08.K21.100	63	8	20	32	38	100	74	37
HA6.W08.K21.100	63	8	20	32	38	100	74	37
HA6.W08.K21.160	63	8	20	32	38	160	134	37
HA6.W10.K21.065	63	10	25	35	-	65	39	41
HA6.W10.K21.100	63	10	25	35	41	100	74	41
HA6.W10.K21.130	63	10	25	35	41	130	104	41
HA6.W10.K21.160	63	10	25	35	41	160	134	41
HA6.W12.K21.080	63	12	30	42	-	80	54	46
HA6.W12.K21.100	63	12	30	42	-	100	74	46
HA6.W12.K21.130	63	12	30	42	48	130	104	46
HA6.W12.K21.160	63	12	30	42	48	160	134	46
HA6.W14.K21.080	63	14	32	45	-	80	54	46
HA6.W14.K21.100	63	14	32	45	-	100	74	46
HA6.W14.K21.130	63	14	32	45	50	130	104	46
HA6.W14.K21.160	63	14	32	45	51	160	134	46
HA6.W16.K21.080	63	16	36	48	-	80	54	49
HA6.W16.K21.100	63	16	36	48	-	100	74	49
HA6.W16.K21.130	63	16	36	48	50	130	104	49
HA6.W16.K21.160	63	16	36	48	50	160	134	49
HA6.W18.K21.080	63	18	38	48	-	80	54	49
HA6.W18.K21.100	63	18	38	48	-	100	74	49
HA6.W18.K21.130	63	18	38	48	50	130	104	49
HA6.W18.K21.160	63	18	38	48	50	160	134	49
HA6.W20.K21.080	63	20	40	52	-	80	54	51
HA6.W20.K21.100	63	20	40	52	-	100	74	51
HA6.W20.K21.130	63	20	40	52	-	130	104	51
HA6.W20.K21.160	63	20	40	52	-	160	134	51
HA6.W25.K21.110	63	25	45	63	-	110	84	59
HA6.W25.K21.160	63	25	45	63	-	160	134	59
HA6.W32.K21.110	63	32	52	72	-	110	84	63

Ersatzteile / Zubehör

Spare parts / Accessories

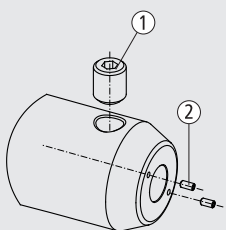

Für Flächenspannfutter	Bestell-Nr. / Order number	Dimension	Bestell-Nr. / Order number	Dimension
For end mill adapter	Klemmscharube / Clamping screw ①		Cool-Jet Verschlusschraube / Screw plug ②	
xxx.W06.xxx.xxx	W06.ER1.001.010	M 6 x 10	ERU.CJ2.001.006	M 3 x 6
xxx.W08.xxx.xxx	W08.ER1.001.010	M 8 x 10	ERU.CJ2.001.006	M 3 x 6
xxx.W10.xxx.xxx	W10.ER1.001.012	M10 x 12	ERU.CJ2.001.006	M 3 x 6
xxx.W12 ... W14.xxx.xxx	W12.ER1.001.016	M12 x 16	ERU.CJ2.001.006	M 3 x 6
xxx.W16 ... W18.xxx.xxx	W16.ER1.001.016	M14 x 16	ERU.CJ2.001.006	M 3 x 6
xxx.W20.xxx.xxx	W20.ER1.001.016	M16 x 16	ERU.CJ2.001.006	M 3 x 6
xxx.W25.xxx.xxx	W25.ER1.001.020	M18 x 2 x 20	ERU.CJ3.001.008	M 4 x 8
xxx.W32 ... W40.xxx.xxx	W32.ER1.001.020	M20 x 2 x 20	ERU.CJ3.001.008	M 4 x 8

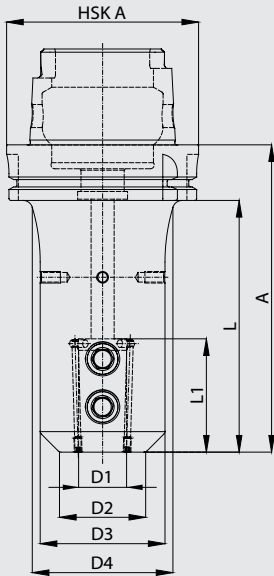

Bestell-Nr. / Order number	HSK A	D1	D2	D3	D4	A	L	L1
HA0.W06.K21.080	100	6	17	30	-	80	51	37
HA0.W06.K21.160	100	6	17	30	38	160	131	37
HA0.W08.K21.080	100	8	20	32	-	80	51	37
HA0.W08.K21.160	100	8	20	32	40	160	131	37
HA0.W10.K21.080	100	10	25	35	-	80	51	41
HA0.W10.K21.160	100	10	25	35	43	160	131	41
HA0.W12.K21.080	100	12	30	42	-	80	51	46
HA0.W12.K21.160	100	12	30	42	50	160	131	46
HA0.W14.K21.080	100	14	32	45	-	80	51	46
HA0.W14.K21.160	100	14	32	45	53	160	131	46
HA0.W16.K21.100	100	16	36	48	-	100	71	49
HA0.W16.K21.160	100	16	36	48	56	160	131	49
HA0.W18.K21.100	100	18	38	48	-	100	71	49
HA0.W18.K21.160	100	18	38	48	56	160	131	49
HA0.W20.K21.100	100	20	40	52	-	100	71	51
HA0.W20.K21.160	100	20	40	52	60	160	131	51
HA0.W25.K21.100	100	25	45	65	-	100	71	59
HA0.W25.K21.160	100	25	45	65	73	160	131	59
HA0.W32.K21.100	100	32	52	72	-	100	71	63
HA0.W32.K21.160	100	32	52	72	80	160	131	63
HA0.W40.K21.110	100	40	60	80	-	110	81	73



Flächenspannfutter Weldon Typ L End mill adapter Weldon type L

- zur Aufnahme von Werkzeugen mit Zylinderschaft nach DIN 1835 B
- Aufnahme feingewuchtet G 2.5/25 000 U/min
- to clamp tools with cylindrical shank according to DIN 1835 B
- fine balanced toolholders G 2.5/25 000 r/min

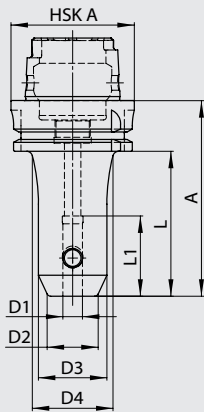

Bestell-Nr. / Order number	HSK A	D1	D2	D3	D4	A	L	L1
HA6.W06.K01.065	63	6	17	30	-	65	39	37
HA6.W06.K01.100	63	6	17	30	36	100	74	37
HA6.W06.K01.130	63	6	17	30	36	130	104	37
HA6.W08.K01.065	63	8	20	32	-	65	39	37
HA6.W08.K01.100	63	8	20	32	38	100	74	37
HA6.W08.K01.130	63	8	20	32	38	130	104	37
HA6.W10.K01.065	63	10	25	35	-	65	39	41
HA6.W10.K01.100	63	10	25	35	41	100	74	41
HA6.W10.K01.130	63	10	25	35	41	130	104	41
HA6.W12.K01.080	63	12	30	42	-	80	54	46
HA6.W12.K01.100	63	12	30	42	-	100	74	46
HA6.W12.K01.130	63	12	30	42	48	130	104	46
HA6.W14.K01.080	63	14	32	45	-	80	54	46
HA6.W14.K01.100	63	14	32	45	-	100	74	46
HA6.W14.K01.130	63	14	32	45	50	130	104	46
HA6.W16.K01.080	63	16	36	48	-	80	54	49
HA6.W16.K01.100	63	16	36	48	-	100	74	49
HA6.W16.K01.130	63	16	36	48	50	130	104	49
HA6.W18.K01.080	63	18	38	48	-	80	54	49
HA6.W18.K01.100	63	18	38	48	-	100	74	49
HA6.W18.K01.130	63	18	38	48	50	130	104	49
HA6.W20.K01.080	63	20	40	52	-	80	54	51
HA6.W20.K01.100	63	20	40	52	-	100	74	51
HA6.W20.K01.130	63	20	40	52	-	130	104	51
HA6.W25.K01.110	63	25	45	63	-	110	84	59
HA6.W32.K01.110	63	32	52	72	-	110	84	63



Spannzangenfutter ER Typ S

Collet chuck ER type S

- für Spannzangen nach DIN 6499
 - zur Aufnahme von Werkzeugen mit Zylinderschaft
 - axiale Längenverstellung
 - Grundkörper feingewuchtet
G 2.5/25000 U/min
- for collets according to DIN 6499
 - to clamp tools with cylindrical shank
 - axial adjustment
 - fine balanced base tool
G 2.5/25000 r/min



Bestell-Nr./ Order number	HSK A	D1	Spannzange / Collet	Spannbereich / Clamping range	D2	A
HA6.E17.K01.100	63	27	ER 16	0.5–10	22	100
HA6.E17.K01.160	63	33	ER 16	0.5–10	22	160
HA6.E25.K01.100	63	37	ER 25	0.5–16	42	100
HA6.E25.K01.160	63	43	ER 25	0.5–16	42	160
HA6.E32.K01.100	63	45	ER 32	1 –20	50	100
HA6.E32.K01.160	63	50	ER 32	1 –20	50	160
HA6.E40.K01.100	63	52	ER 40	2 –30	63	100
HA6.E40.K01.160	63	52	ER 40	2 –30	63	160

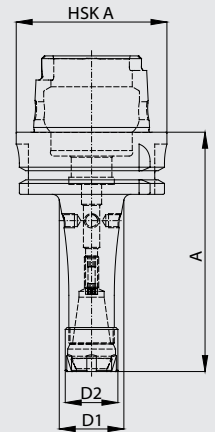

Bestell-Nr./ Order number	HSK A	D1	Spannzange / Collet	Spannbereich / Clamping range	D2	A
HA0.E17.K01.100	100	27	ER 16	0.5–10	22	100
HA0.E17.K01.160	100	33	ER 16	0.5–10	22	160
HA0.E17.K01.200	100	33	ER 16	0.5–10	22	200
HA0.E25.K01.100	100	37	ER 25	0.5–16	42	100
HA0.E25.K01.160	100	37	ER 25	0.5–16	42	160
HA0.E25.K01.200	100	43	ER 25	0.5–16	42	200
HA0.E32.K01.100	100	45	ER 32	1 –20	50	100
HA0.E32.K01.160	100	51	ER 32	1 –20	50	160
HA0.E32.K01.200	100	51	ER 32	1 –20	50	200
HA0.E40.K01.100*	100	56	ER 40	2 –30	63	100
HA0.E40.K01.160	100	63	ER 40	2 –30	63	160
HA0.E40.K01.200	100	63	ER 40	2 –30	63	200

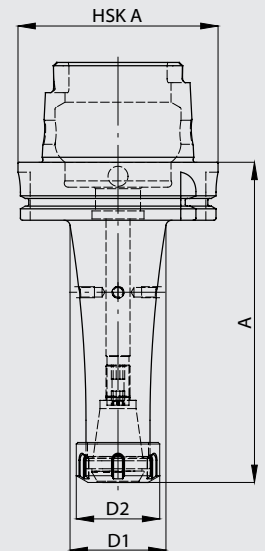

* Ohne axiale Längenverstellung

* without axial adjustment

• Spannzangen und Spannschlüssel siehe Preisliste

• collets and clamping keys see price list

Ersatzteile / Zubehör

Spare parts / Accessories

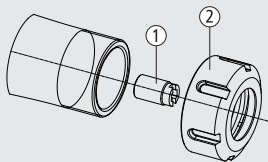

Für Spannzangenfutter	Bestell-Nr. / Order number	Dimension	Bestell-Nr. / Order number	Dimension
For collet chuck	Anschlagschraube / Stop screw ①		Spannmutter / Clamping nut ②	
xxx.E17.xxx.xxx	ERU.AN2.K01.016	M 6 x 16	E17.ER1.001.018	M19 x 1
xxx.E25.xxx.xxx	ERU.AN5.K01.020	M12 x 1 x 20	E25.ER1.001.020	M32 x 1.5
xxx.E32.xxx.xxx	ERU.AN5.K01.020	M12 x 1 x 20	E32.ER1.001.023	M40 x 1.5
xxx.E40.xxx.xxx	ERU.AN5.K01.020	M12 x 1 x 20	E40.ER1.001.025	M50 x 1.5

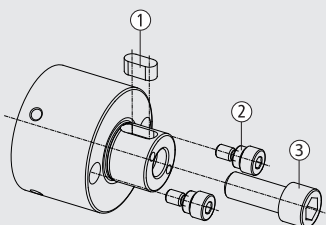

Für Fräsdorn	Bestell-Nr. / Order number	Bestell-Nr. / Order number	Bestell-Nr. / Order number	Dimension
For milling arbors	Passfeder / Fitting key ①	Mitnehmerbolzen / Drive bolt ②	Fräseranzugschraube / Clamping screw ③	
xxx.D16.xxx.xxx	D16.ER3.001.014	D16.ER2.001.015	D16.ER1.002.025	M 8 x 25
xxx.D22.xxx.xxx	D22.ER3.001.014	D22.ER2.001.017	D22.ER1.002.025	M10 x 25
xxx.D27.xxx.xxx	D27.ER3.001.018	D27.ER2.001.021	D27.ER1.002.030	M12 x 30
xxx.D32.xxx.xxx	D32.ER3.001.020	D32.ER2.001.022	D32.ER1.002.035	M16 x 35
xxx.D40.xxx.xxx	D40.ER3.001.022	D40.ER2.001.023	D40.ER1.002.040	M20 x 40

Fräsdorn Typ S

Milling arbor type S

- zur Aufnahme von Fräsern mit Längs- und Quernut
- eingeschraubte Mitnehmerbolzen
- Aufnahmen feingewuchtet G 2.5/18000 U/min

- to clamp milling cutters with longitudinal and cross drive
- screwed drive bolt
- fine balanced toolholders G 2.5/18000 r/min

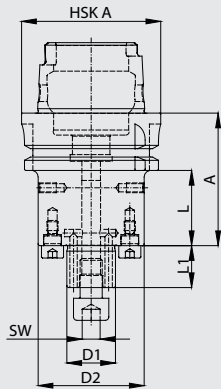

Bestell-Nr. / Order number	HSK A	D1	D2	SW	A	L	L1
HA6.D16.K01.060	63	16	38	6	60	34	17
HA6.D16.K01.100	63	16	38	6	100	74	17
HA6.D16.K01.160	63	16	38	6	160	134	17
HA6.D22.K01.060	63	22	48	8	60	34	19
HA6.D22.K01.100	63	22	48	8	100	74	19
HA6.D22.K01.160	63	22	48	8	160	134	19
HA6.D27.K01.060	63	27	58	10	60	34	21
HA6.D27.K01.100	63	27	58	10	100	74	21
HA6.D27.K01.160	63	27	58	10	160	134	21
HA6.D32.K01.060	63	32	72	12	60	34	24
HA6.D32.K01.100	63	32	72	12	100	74	24
HA6.D32.K01.160	63	32	72	12	160	134	24
HA6.D40.K01.070	63	40	80	14	70	44	27
HA6.D40.K01.100	63	40	80	14	100	74	27
HA6.D40.K01.160	63	40	80	14	160	134	27

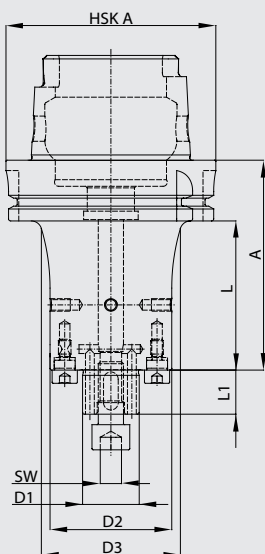

Bestell-Nr. / Order number	HSK A	D1	D2	D3	SW	A	L	L1
HA0.D16.K01.060	100	16	38	-	6	60	31	17
HA0.D16.K01.100	100	16	38	46	6	100	71	17
HA0.D16.K01.160	100	16	38	46	6	160	131	17
HA0.D22.K01.060	100	22	48	-	8	60	31	19
HA0.D22.K01.100	100	22	48	56	8	100	71	19
HA0.D22.K01.160	100	22	48	56	8	160	131	19
HA0.D27.K01.060	100	27	58	-	10	60	31	21
HA0.D27.K01.100	100	27	58	66	10	100	71	21
HA0.D27.K01.160	100	27	58	66	10	160	131	21
HA0.D32.K01.060	100	32	72	-	12	60	31	24
HA0.D32.K01.100	100	32	72	80	12	100	71	24
HA0.D32.K01.160	100	32	72	80	12	160	131	24
HA0.D40.K01.070	100	40	80	-	14	70	41	27
HA0.D40.K01.100	100	40	80	-	14	100	71	27
HA0.D40.K01.160	100	40	80	-	14	160	131	27



Differentialschraube

ersetzt Fräseranzugschraube

Differential screw

substitutes clamping screw

- für extrem hohe Anzugsmomente
- Kühlmittelfluss siehe Seite 4

- for extremely high clamping torque
- coolant see page 4

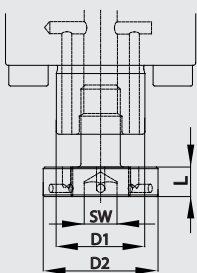

Bestell-Nr. / Order number	M	D1	D2	SW	L	P Δ
D16.ER1.K61.012	8	16	20	6	7	0.25
D22.ER1.K61.016	10	22	28	8	8	0.5
D27.ER1.K61.018	12	27	35	10	9	0.75
D32.ER1.K61.024	16	32	42	12	10	1
D40.ER1.K61.030	20	40	52	14	11	1.5

- Delta P entspricht der Steigungsdifferenz

- delta P consists with the pitch difference



Gewindeschneidfutter Typ S

Tapping chuck type S

- für Schnellwechseleinsätze «System Bilz»
- ohne Längenausgleich für Maschinen mit synchronisiertem Gewindeschneiden
- mit Innenkühlung

- for quick change adapter «System Bilz»
- without length-compensation for machines with synchronized tapping
- with inner coolant supply



Bestell-Nr. / Order number	HSK A	M	D	D1	D2	A	L
HA6.Go1.K01.080	63	M3–M14	19	32	34	80	54
HA6.Go1.K01.160	63	M3–M14	19	32	40	160	134
HA6.Go2.K01.100	63	M6–M24	31	50	52	100	74
HA6.Go2.K01.160	63	M6–M24	31	50	52	160	134
HA6.Go3.K01.120	63	M14–M36	48	72	72	120	94

Bestell-Nr. / Order number	HSK A	M	D	D1	D2	A	L
HA0.Go1.K01.090	100	M3–M14	19	32	34	90	61
HA0.Go1.K01.160	100	M3–M14	19	32	40	160	131
HA0.Go2.K01.110	100	M6–M24	31	50	52	110	81
HA0.Go2.K01.160	100	M6–M24	31	50	60	160	131
HA0.Go3.K01.130	100	M14–M36	48	72	72	130	101

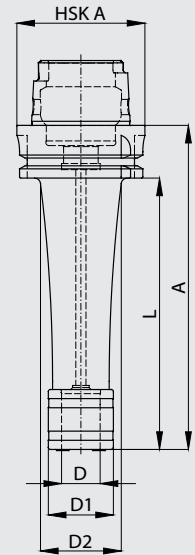

Schnellwechseleinsätze

Quick-change adapters

- zur Aufnahme von Gewindebohrern nach DIN 371 und DIN 376
- für Gewindeschneidfutter «System Bilz»
- mit drei Aussenkühlbohrungen

- to clamp taps according to DIN 371 and DIN 376
- for tapping chuck «System Bilz»
- with three exterior cooling holes



Bestell-Nr. / Order number	D	D1 Ø / □	D2	L
Go1.U03.K31.007	19	3.5 / 2.7	32	7
Go1.U04.K31.007	19	4.0 / 3.0	32	7
Go1.U05.K31.007	19	4.5 / 3.4	32	7
Go1.U06.K31.007	19	6.0 / 4.9	32	7
Go1.U07.K31.007	19	7.0 / 5.5	32	7
Go1.U08.K31.007	19	8.0 / 6.2	32	7
Go1.U09.K31.007	19	9.0 / 7.0	32	7
Go1.U10.K31.007	19	10.0 / 8.0	32	7
Go1.U11.K31.007	19	11.0 / 9.0	32	7
Go2.U06.K31.011	31	6.0 / 4.9	50	11
Go2.U07.K31.011	31	7.0 / 5.5	50	11
Go2.U08.K31.011	31	8.0 / 6.2	50	11
Go2.U09.K31.011	31	9.0 / 7.0	50	11
Go2.U10.K31.011	31	10.0 / 8.0	50	11
Go2.U11.K31.011	31	11.0 / 9.0	50	11
Go2.U12.K31.011	31	12.0 / 9.0	50	11
Go2.U14.K31.011	31	14.0 / 11.0	50	11
Go2.U16.K31.011	31	16.0 / 12.0	50	11
Go2.U18.K31.011	31	18.0 / 14.5	50	11

